

## Solid-State Memory Camcorder

### Operating Guide

Identifying Parts and  
Controls

Getting Started

Recording

Playback

Using Network Functions

Editing

Using the Menu

Troubleshooting

Additional Information



# Read this first

Before operating this unit, please read this manual thoroughly, and retain it for future reference.

## Precautions when using the camcorder

- Do not hold the camcorder by the following parts, and also do not hold the camcorder by the jack covers.

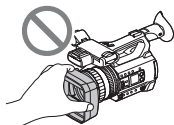

Lens cover with hood

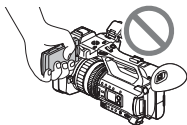

LCD screen

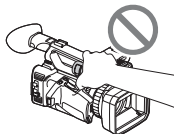

Microphone (sold separately) or Microphone holder

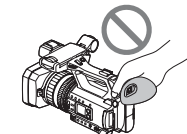

Viewfinder

## Notes

- The camcorder is not dustproof, dripproof or waterproof. See "About handling of your camcorder" (p. 139).
- When connecting the camcorder to another device with communication cables, be sure to insert the connector plug in the correct way. Pushing the plug forcibly into the terminal will damage the terminal and may result in a malfunction of the camcorder.
- Use the camcorder in accordance with the regulations of a place where you use it.

## On the LCD screen and lens

- A menu item that is grayed out is not available under the current recording or playback conditions.
- The LCD screen is manufactured using extremely high-precision technology, so over 99.99% of the pixels are operational for effective use. However, there may be some tiny black points and/or bright points (white, red, blue, or green in color) that appear constantly on

the LCD screen. This is not a malfunction. These points are normal results of the manufacturing process and do not affect the recording in any way.

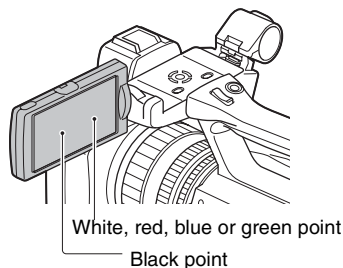

## On sunlight

- Do not record the sun or leave the camcorder under the sun for a long time. The internal parts of the camcorder may be damaged. If sunlight is focused on a nearby object, it may cause a fire.
- Do not expose your camcorder's viewfinder, lens, or LCD screen to the sun or strong light source for extended periods. Doing so may cause a malfunction of the camcorder.
- Do not attempt to record the sun directly. Doing so may cause a malfunction of the camcorder.
- Do not expose the lens to beams, such as laser beams. That may damage the image sensor and cause the camera to malfunction.

## On the temperature of your camcorder and battery pack

Your camcorder has a protective function that disables recording or playback if the temperature of your camcorder or battery pack is beyond the safely operable range. In this case, a message appears on the LCD screen or in the viewfinder (p. 122).

## On recording

- In order to stabilize memory card operation, it is recommended that you format the memory card when you use it with your camcorder for the first time. All data recorded on the memory card will be erased by formatting, and cannot be

recovered. Save important data on the memory card on other media such as a computer, before formatting the memory card.

- Before starting to record, test the recording function to make sure the picture and sound are recorded without any problems.
- Compensation for the loss of the content of recordings or the loss of recording opportunities cannot be provided, even if recording or playback is not possible due to a malfunction of the camcorder, storage media, etc., or even if images or sounds are distorted due to the limits of the capabilities of the camcorder.
- TV color systems differ depending on the countries/regions. To view your recordings on a TV, a TV of the appropriate color system for the country/region is required.
- Television programs, films, video tapes, and other materials may be copyrighted. Unauthorized recording of such materials may be contrary to the copyright laws.
- Because of the way that the image device (CMOS sensor) reads out image signals, the following phenomena may occur.
  - The subjects passing by the frame rapidly might appear crooked depending on the recording conditions. (This phenomenon may be notable in displays having high motion resolution.)
  - Horizontal lines appear on the LCD screen during recording under fluorescent lights, sodium lamps or mercury lamps. The phenomena can be reduced by adjusting the shutter speed (p. 41).

## Save all your recorded image data

- To prevent your image data from being lost, save all your recorded images on PC periodically.

## To handle the recorded images on your computer

Download software (p. 20).

## Format the memory card using [MEDIA FORMAT] if images are not recorded or played back properly

If you continue recording and deleting images on a memory card for a long period of time, the files on that memory card may become fragmented. As

a result, you may not be able to record and save images properly. If this happens, save images on a PC, then format the memory card (p. 96).

## About the operation of the camcorder

You can operate the camcorder using the **▶/▶/◀/◀/▶/SET** buttons (p. 98).

## About this manual

- The on-screen display in English is used for illustrating the operating procedures. Change the screen language before using your camcorder if necessary (p. 113).
- The value you can set in [REC FORMAT], etc., depends on the [60i/50i SEL] setting. In this manual, the values for both [60i] and [50i] settings are described.
- Design and specifications of recording media and other accessories are subject to change without notice.

# Table of Contents

Read this first .....	2
-----------------------	---

## Identifying Parts and Controls

Identifying Parts and Controls .....	8
Body .....	8
Wireless Remote Commander .....	16
Screen Indicators .....	17

## Getting Started

Step 1: Checking supplied accessories .....	19
Step 2: Charging the battery pack .....	20
Step 3: Attaching the accessory shoe .....	22
Step 4: Turning on the camcorder and setting the date and time .....	23
Turning on the camcorder .....	23
Setting the date and time .....	23
Step 5: Adjusting the LCD screen and viewfinder .....	24
Using the LCD screen .....	24
Using the viewfinder .....	24
Adjusting the viewfinder focus .....	25
Switching between LCD screen display and viewfinder display .....	25
Step 6: Inserting a memory card .....	27

## Recording

Recording .....	29
Recording .....	29
Continuous recording on the memory cards (Relay Rec) .....	31
Recording movies using both memory card A and B (Simul Rec) ....	32
Changing the setting of the START/STOP button and handle record button .....	32
Adjusting the zoom .....	33
Adjusting the focus .....	34
Focusing using the focus magnifier .....	34
Focusing on a detected face (Face detection) .....	35
Selecting the file format and recording format .....	37
Supported file formats .....	37
Setting the file format and recording format .....	37
Setting the output destination when recording in 4K mode .....	38
Proxy recording .....	39
Notes on proxy recording .....	39
Proxy recording .....	39

Adjusting the brightness .....	40
Adjusting the iris .....	40
Adjusting the gain .....	41
Adjusting the shutter speed .....	41
Adjusting the light level (ND filter) .....	42
Adjusting the color tone .....	43
Adjusting the white balance .....	43
Audio setup .....	45
Recording sound from the internal microphone .....	45
Recording sound from an external audio device .....	46
Recording sound from a Multi Interface Shoe compatible microphone (sold separately) .....	46
Setting the audio recording level .....	47
Setting the headphone sound .....	47
Useful functions .....	48
Selecting suitable settings automatically (auto mode setting) .....	48
Shooting in dimly lit locations (LOW LUX) .....	49
Shooting in dark conditions (NIGHTSHOT) .....	49
Customizing the picture quality (Picture Profile) .....	50
Setting time data .....	57
Slow-motion recording at high frame rate (HFR) .....	58
Recording with the Slow & Quick Motion function .....	58
Reviewing the most recently recorded scene (Last Scene Review) .....	61
Assigning functions to the ASSIGN buttons .....	62

## Playback

Playback .....	64
Playback .....	64
Changing/checking the settings in your camcorder .....	68
Changing the screen display .....	68
Displaying recording data (Data Code) .....	68
Checking the settings in your camcorder (Status Check) .....	69
Connecting to a monitor or a TV .....	70
Selecting jacks for external output .....	71
Output signal formats .....	72

## Using Network Functions

Using with a Smartphone .....	78
Downloading "Content Browser Mobile" .....	78
Using a smartphone as a remote controller .....	78
Connecting the camcorder to an Android smartphone equipped with the NFC function using One-touch .....	79
Connecting without using the NFC function (Android) .....	80

## Table of Contents (Continued)

Connecting without using the NFC function (iPhone/iPad) .....	81
<b>Configuring a wireless LAN .....</b>	<b>82</b>
Selecting and registering an access point .....	82
Registering an access point using the WPS function .....	83
Registering an access point using the WPS PIN method .....	84
Registering an access point manually .....	84
Changing the device name .....	85
<b>Configuring a wired LAN .....</b>	<b>86</b>
<b>Using the streaming function (STREAMING) .....</b>	<b>87</b>
Streaming formats .....	87
Configuring streaming (preset registration) .....	87
Streaming distribution .....	88
<b>Using the FTP transfer function .....</b>	<b>89</b>
Registering an FTP server .....	89
Selecting an FTP server .....	90
Using FTP transfer .....	90
Checking FTP transfer results .....	91
<b>Importing a root certificate .....</b>	<b>92</b>
<b>Resetting network settings .....</b>	<b>93</b>

## Editing

Protecting movies (Protect) .....	94
Dividing a movie .....	94
Deleting movies .....	95
Formatting a memory card .....	96
Deleting all data from the memory card completely .....	96
Repairing the image database file .....	97

## Using the Menu

Operating the menu .....	98
<b>Menu items .....</b>	<b>99</b>
CAMERA SET menu .....	99
REC/OUT SET menu .....	102
AUDIO SET menu .....	104
DISPLAY SET menu .....	107
TC/UB SET menu .....	110
NETWORK SET menu .....	111
OTHERS menu .....	113
EDIT menu .....	114

## Troubleshooting

Troubleshooting .....	115
Warning indicators and messages .....	122

## Additional Information

Recording time .....	126
Function limitations when recording .....	129
Limitations for each file format .....	129
Slow & Quick Motion and High Frame Rate recording limitations ...	130
Proxy recording supported formats .....	131
Streaming supported formats .....	132
Using your camcorder abroad .....	134
File/folder structure on the recording media .....	135
Maintenance and precautions .....	136
About the XAVC format .....	136
About the MPEG format .....	136
About the AVCHD format .....	136
About memory cards .....	136
About the "InfoLITHIUM" battery pack .....	137
About handling of your camcorder .....	139
Specifications .....	142
Index .....	145

# Identifying Parts and Controls

## Body

The numbers in ( ) are reference pages.

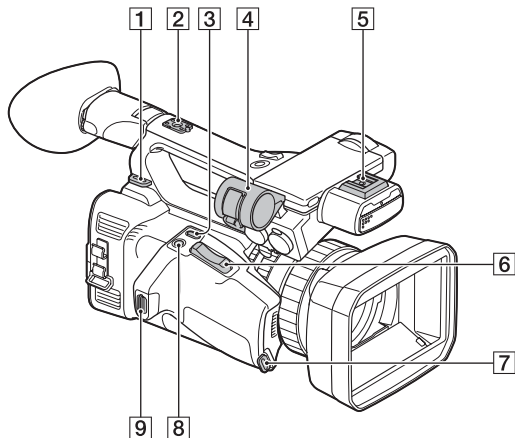

- 1 Hook for shoulder strap
- 2 Accessory shoe receptacle (p. 22)
- 3 ASSIGN4/LAST SCENE button (p. 61)
- 4 Microphone holder (p. 9)
- 5 Multi Interface Shoe (p. 46)
- 6 Power zoom lever (p. 33)
- 7 Grip belt attachment
- 8 ASSIGN5/FOCUS MAG button (p. 34)
- 9 Grip belt attachment



## Attaching the microphone (sold separately)

This section explains how to connect an external microphone (sold separately).

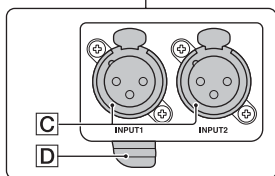
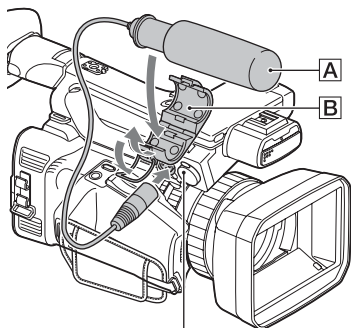

- ① Place the microphone **A** into the microphone holder **B**.
- ② Connect the plug of the microphone to the INPUT1 jack or INPUT2 jack **C**.
- ③ Place the microphone cable into the cable holder **D**.

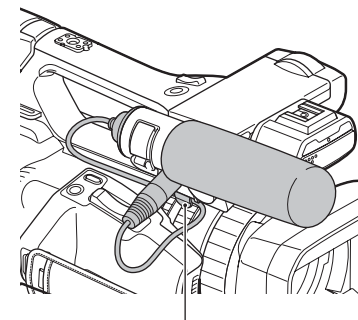

Put the cable in the outer cable holder.

## Identifying Parts and Controls (Continued)

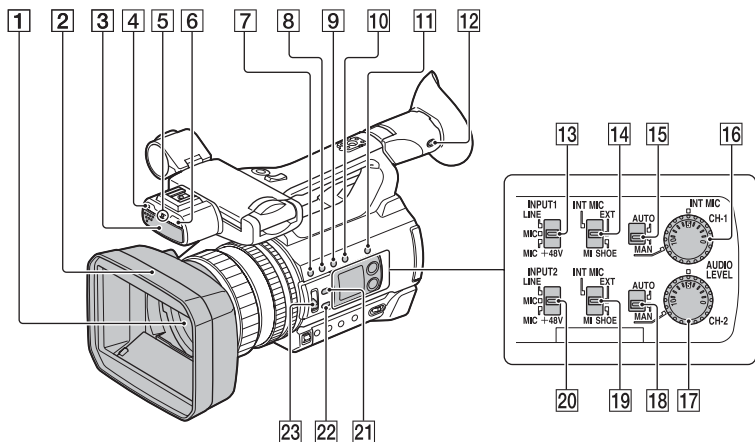

- 1** Lens (G lens)
- 2** Lens cover with hood (p. 11)
- 3** Internal microphone (p. 45)
- 4** Remote control sensor (p. 16)
- 5** Recording lamp (p. 113)  
Flashes when remaining capacity of the memory card or battery becomes low.
- 6** NIGHTSHOT light emitter (p. 49)
- 7** ASSIGN1/WB SET button (44, 62)
- 8** ASSIGN2/STATUS button (62, 69)
- 9** ASSIGN3/S&Q button (p. 58)
- 10** DISPLAY button (p. 68)
- 11** SLOT SEL button (p. 28)
- 12** ASSIGN6/VF/LCD PANEL button (p. 26)
- 13** INPUT1 (LINE/MIC/MIC+48V) switch (p. 45)
- 14** CH-1 (INT MIC/EXT/MI SHOE) switch (p. 45)
- 15** AUTO/MAN (CH-1) switch (p. 45)
- 16** AUDIO LEVEL (CH-1) dial (p. 45)
- 17** AUDIO LEVEL (CH-2) dial (p. 45)
- 18** AUTO/MAN (CH-2) switch (p. 45)
- 19** CH-2 (INT MIC/EXT/MI SHOE) switch (p. 45)
- 20** INPUT2 (LINE/MIC/MIC+48V) switch (p. 45)
- 21** IRIS AUTO/MAN button (p. 40)
- 22** FOCUS AUTO/MAN button (p. 34)
- 23** ND FILTER switch (p. 42)

## Attaching the lens cover with hood

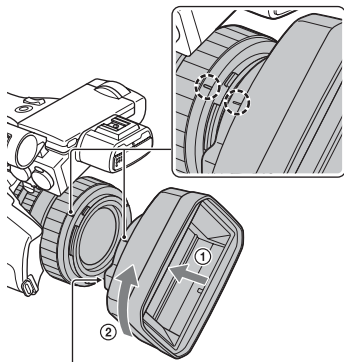

PUSH (lens hood removal) button

Align the marks on the lens hood to those on the camcorder, and turn the lens hood in the direction of the arrow ② until it is locked.

## Removing the lens cover with hood

Press and hold the PUSH (lens hood removal) button, and turn the lens hood in the opposite direction to the arrow.

### 💡 Tip

- If you attach or remove a 62 mm (2 1/2 in.) PL filter or MC protector, remove the lens hood.

## Opening/closing the lens cover

To open the lens cover, move the lens cover lever to the OPEN position. To close it, move it to the CLOSE position.

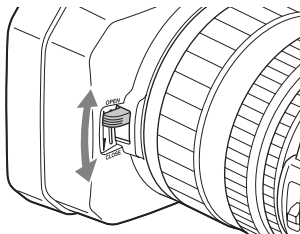

## Identifying Parts and Controls (Continued)

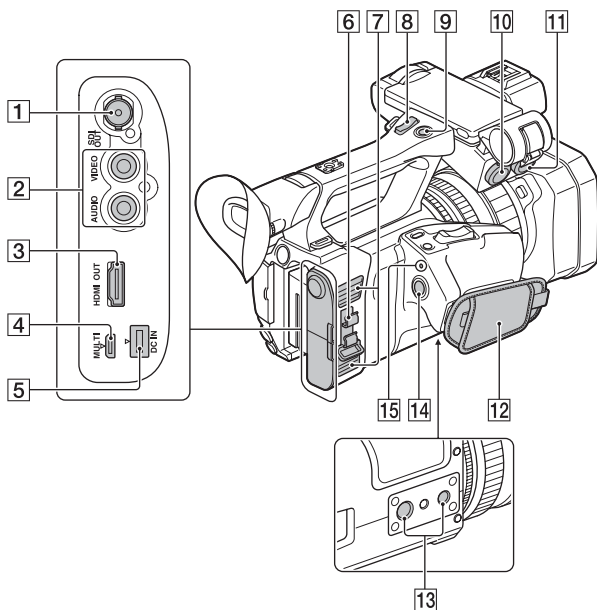

- 1** SDI OUT jack (p. 70)
- 2** VIDEO OUT jack/AUDIO OUT jack (p. 70)
- 3** HDMI OUT jack (p. 70)
- 4** Multi/Micro USB jack (p. 70)
- 5** DC IN jack (p. 20)
- 6** Cable clamber/loop clamber
- 7** Air vents  
May become warm due to heat dissipation.  
Do not block the vents when shooting.
- 8** Handle zoom lever (p. 33)
- 9** Handle record button (p. 29)
- 10** INPUT1 jack (p. 45)
- 11** INPUT2 jack (p. 45)
- 12** Grip belt

- 13** Tripod receptacles (1/4 inch, 3/8 inch)  
Supports 1/4-20UNC and 3/8-16UNC screws.  
For mounting on a tripod (sold separately, screw length 5.5 mm or shorter)  
Some tripods may not be designed to attach in the proper direction.
- 14** START/STOP button (p. 29)
- 15** POWER/CHG lamp (p. 30)

### Cable clamber/loop clamber

Attaching the power cord, HDMI cable, and other cables, inserted in the corresponding connectors, in the cable clamber helps prevent the cords from being disconnected. However, not all HDMI cables are supported.

Attach any cables that are not in the cable clamber to the loop clamber at the bottom

of the cable clasper using a cable tie or similar object.

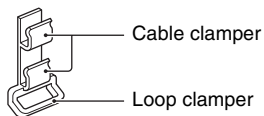

**Note**

- Do not use the cable clasper/loop clasper for any purpose other than securing cables (for example, attaching a strap for carrying the camcorder).

## Identifying Parts and Controls (Continued)

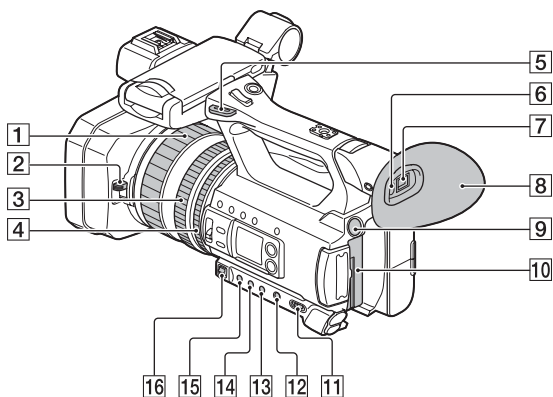

- 1** Focus ring (p. 34)
- 2** Lens cover lever (p. 11)
- 3** Zoom ring (p. 33)
- 4** Iris ring (p. 40)
- 5** Hook for shoulder strap
- 6** Eye sensor (p. 24)
- 7** Viewfinder (p. 25)
- 8** Large eyecup (p. 25)
- 9** BATT RELEASE button (p. 21)
- 10** Battery pack (p. 20)
- 11** ON/STANDBY switch (p. 23)
- 12** FULL AUTO button (p. 48)
- 13** SHUTTER button (p. 41)
- 14** WHT BAL button (p. 43)
- 15** GAIN button (p. 41)
- 16** Manual lever (p. 41, 43)

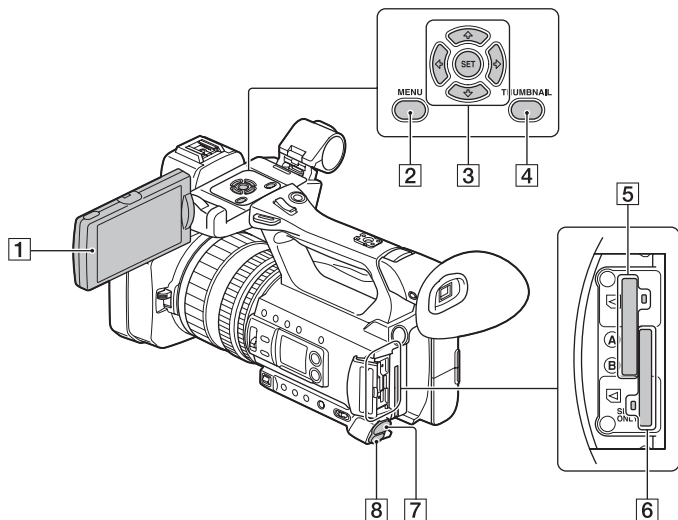

- 1** LCD screen (p. 24)
- 2** MENU button (p. 98)
- 3**  $\blacktriangle$ / $\blacktriangledown$ / $\blacktriangleleft$ / $\blacktriangleright$ /SET buttons (p. 98)
- 4** THUMBNAIL button (p. 64)
- 5** Memory card slot A/Memory card access lamp (p. 27)
- 6** Memory card slot B/Memory card access lamp (p. 27)
- 7**  $\odot$  (headphones) jack (p. 47)
- 8** REMOTE jack (p. 113)  
The REMOTE jack connects to a video deck or other devices used to control playback.

### Wireless Remote Commander

Remove the insulation sheet before using the Wireless Remote Commander.

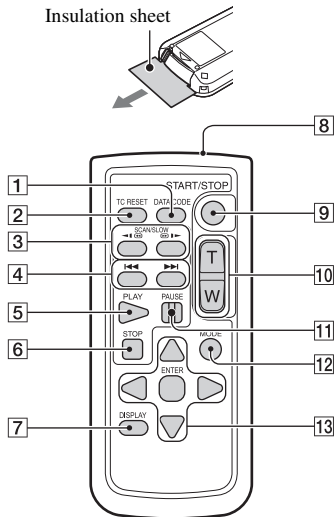

- 1 DATA CODE button (p. 68)
- 2 TC RESET button (p. 57)
- 3 SCAN/SLOW buttons (p. 64)
- 4 ◀▶ (PREV/NEXT) buttons (p. 64)
- 5 PLAY button (p. 64)
- 6 STOP button (p. 64)
- 7 DISPLAY button (p. 68)
- 8 Transmitter
- 9 START/STOP button (p. 29)
- 10 Power zoom lever
- 11 PAUSE button (p. 64)
- 12 MODE button
- 13 ◀/▶/▲/▼/ENTER buttons

### Notes

- Aim the Wireless Remote Commander towards the remote sensor to operate your camcorder.
- Point the remote sensor away from strong light sources such as direct sunlight or overhead lighting. Otherwise, the Wireless Remote Commander may not function properly.
- When you are operating with the Wireless Remote Commander supplied with your camcorder, your video device may also operate. In that case, select a commander mode other than DVD2 for your video device, or cover the sensor of your video device with black paper.

### To change the battery of the Wireless Remote Commander

- ① While pressing on the tab, inset your fingernail into the slit to pull out the battery case.
- ② Place a new battery with the + side facing up.
- ③ Insert the battery case until it clicks into place.

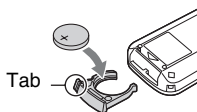

### WARNING

Battery may explode if mistreated. Do not recharge, disassemble or dispose of in fire.

- When the lithium battery becomes weak, the operating distance of the Wireless Remote Commander may shorten, or the Wireless Remote Commander may not function properly. In this case, replace the battery with a CR2025 lithium battery. Use of another battery may present a risk of fire or explosion.



# Screen Indicators

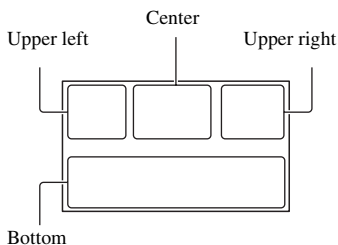

## Upper left

Indicator	Meaning
	100% Remaining battery
	INTELLIGENT AUTO (face detection/scene detection/camera-shake detection) (p. 48)
	SCENE SELECTION (p. 48)
	Recording format (p. 37)
	Optical zoom (p. 100)
	Clear image zoom (p. 100)
	Digital zoom (p. 100)
	Simultaneous recording (p. 32)
	Relay recording (p. 31)
	Proxy recording [ON] (p. 39)

## Center

Indicator	Meaning
	Vibration warning
	Memory card (p. 27)
REC STBY	Recording standby (p. 30)

Indicator	Meaning
	Warning (p. 122)
	Playback indicator (p. 64)
	Processing
	Relay recording (p. 31)
	SDI/HDMI REC CONTROL (p. 104)









## Upper right

Indicator	Meaning
	VF/LCD PANEL (p. 25)
0min	Estimated remaining recording time
	Recording/playback media
00:00:00:00	Time code (hour:minute:second:frame) (p. 57)

## Bottom

Indicator	Meaning
	Face detection [ON] (p. 35)
<b>PEAKING</b>	Peaking (p. 107)
	Zebra (p. 107)
	NFC active (p. 79)
	Airplane mode [ON] (p. 112)
	Image stabilization (STEADYSHOT) (p. 100)
	Manual focus (p. 34)
<b>PP1</b> to <b>PP6</b>	Picture profile (p. 50)
F5.6	Iris (p. 40)
9dB	Gain (p. 41)
100 180°	Shutter speed (p. 41)
	AVCHD audio format (p. 104)
-2.0EV	AE shift (p. 99)
	Auto setting (p. 40)

## Screen Indicators (Continued)

Indicator	Meaning
	White balance (p. 43)
	Histogram (p. 107)
	LOW LUX (p. 49)
	Audio level display (p. 109)
	Digital extender (p. 99)
	NIGHTSHOT (p. 49)
	ND filter (p. 42)
	Multi Interface Shoe video light (p. 101)
	Manual volume adjustment (p. 47)

### Tip

- Indicators may look different or appear at different positions.

### Data during recording

The date, time, and recording conditions are recorded automatically.

They are not displayed while recording.

However, you can check them by selecting

 (DISPLAY SET) → [DATA CODE] and choosing the data that you want to display, or by pressing the ASSIGN button to which the DATA CODE function is assigned, during playback.

# Step 1: Checking supplied accessories

Make sure that you have following items supplied with your camcorder. If, for any reason, there is something missing, contact your Sony dealer.

The number in the parentheses indicates the number of that item supplied.

- Memory cards are sold separately.

AC Adaptor (p. 20)

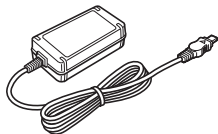

Power cord (mains lead) (p. 20)



IS1293 power cord for India.  
Not supplied in some countries.



RMT-845 Wireless Remote Commander  
(p. 16)



A button-type lithium battery is already installed.

Large eyecup (p. 25)



Lens cover with hood (p. 11)

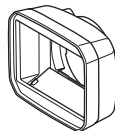

Accessory shoe kit (Accessory shoe (1),  
Accessory shoe plate (1), screws (4))  
(p. 22)

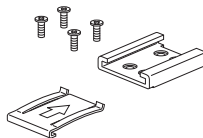

USB cable

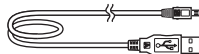

Rechargeable battery pack (NP-F770)

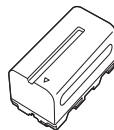

Battery charger (BC-L1)

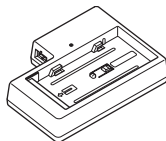

CD-ROM "Manuals for Solid-State Memory  
Camcorder"

Operating Guide (2)

## Step 1: Checking supplied accessories (Continued)

### Software Downloads

When the unit is used with a PC connection, download any device drivers, plug-ins, and application software you require from the following websites.

You can work with recorded video on a computer, for example, combining relay-recorded movies, using the “Catalyst Browse” application software. For details, see the supplied brochure.

Sony Professional products website:

U.S.A. <http://pro.sony.com>

Canada <http://www.sonybiz.ca>

Latin America

<http://sonypro-latin.com>

Europe, Middle East, and Africa

<http://www.pro.sony.eu>

Japan <http://www.sonybsc.com>

Asia Pacific

<http://pro.sony-asia.com>

Korea <http://bp.sony.co.kr>

China <http://pro.sony.com.cn>

Although the data regarding recorded materials are stored over multiple files and folders, you can easily handle the clips without considering its data and directory structure, by using the dedicated application software.

## Step 2: Charging the battery pack

You can charge the “InfoLITHIUM” battery pack (L series) (sold separately) with the supplied AC Adaptor.

### Note

- You can use a large capacity battery pack, NP-F970 (sold separately), with your camcorder.

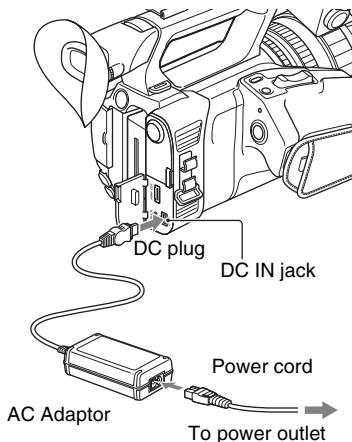

- 1 Push the battery in and slide it down into position.

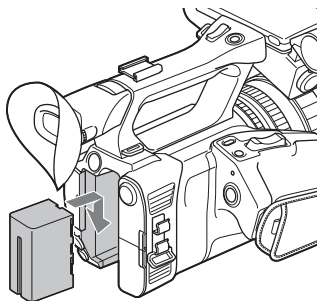

## 2 Connect the DC plug to the DC IN jack of the camcorder.

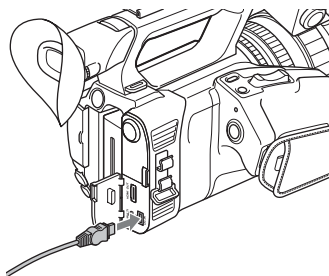

## 3 Connect the power cord (mains lead) to the AC Adaptor and the wall outlet (wall socket).

## 4 Turn the ON/STANDBY switch to STANDBY (⏻).

The CHG lamp lights up and charging starts.

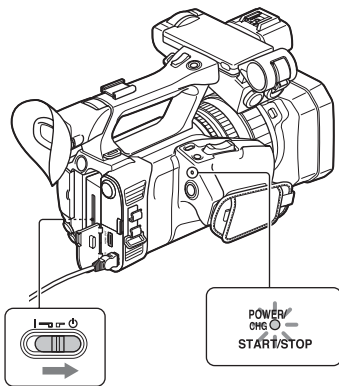

## When charging ends

The CHG lamp turns off when the battery is fully charged.

Disconnect the AC Adaptor from the DC IN jack.

### Tip

- You can check the remaining battery life with the status check function (p. 69).

## To remove the battery pack

Turn the ON/STANDBY switch to STANDBY (⏻). Press and hold the BATT RELEASE button, and slide the battery up and out.

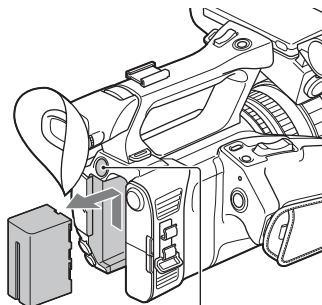

BATT RELEASE button

## To store the battery pack

If the battery pack is not in use for a while, run down the battery and store it (p. 138).

## Charging time

Approximate time (minutes) required when you charge a fully discharged battery pack.

Battery pack	Full charge time
NP-F770	420 minutes
NP-F970	600 minutes

(sold separately)

## Step 2: Charging the battery pack (Continued)

### On the battery pack

- Always turn the ON/STANDBY switch to STANDBY (⏻) before changing the battery pack.
- The CHG lamp flashes during charging, or the Battery Info will not be correctly displayed under the following conditions.
  - The battery pack is not attached correctly.
  - The battery pack is damaged.
  - The battery pack is worn-out.

### Using a power outlet

You can use the AC Adaptor to obtain the AC power. While you are using the AC Adaptor, the battery pack will not lose its charge even when it is attached to your camcorder.

Perform the procedure up to step **3** of “Step 2: Charging the battery pack” (p. 20).

### On the AC Adaptor

- Do not short-circuit the DC plug of the AC Adaptor or battery terminal with any metallic objects. This may cause a malfunction.

## Step 3: Attaching the accessory shoe

### To mount the accessory shoe

Mount the accessory shoe on the accessory shoe mount as illustrated.

Accessory shoe plate

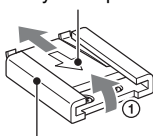

Accessory shoe

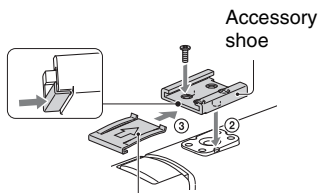

Accessory shoe plate

- ① Lift the edge of the accessory shoe plate and pull it in the direction opposite to that of the arrow on the accessory shoe plate and remove it from the accessory shoe.
- ② Place the accessory shoe as its protrusions matches recesses of the accessory shoe mount, then fix it to the mount with four screws.
- ③ Insert the accessory shoe plate in the direction of the arrow on the plate surface until the end of the plate engages the end of the shoe.

### To remove the accessory shoe

Remove the shoe plate in the same way as step ① of “To mount the accessory shoe.” Loosen the 4 screws and remove the accessory shoe from the accessory shoe mount.

# Step 4: Turning on the camcorder and setting the date and time

## Turning on the camcorder

Turn the ON/STANDBY switch to ON (I).

When you use your camcorder for the first time, the [CLOCK SET] screen appears.

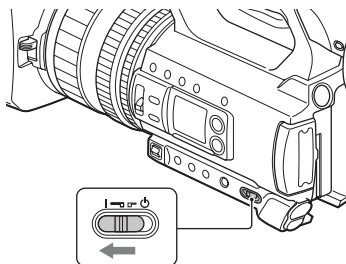

## To turn off the power

Turn the ON/STANDBY switch to STANDBY (⏻).

### Note

- If a warning message is displayed, follow the instructions.

## Setting the date and time

Set the date and time when you use your camcorder for the first time.

### Tip

- If you do not use your camcorder for about **3 months**, the built-in rechargeable battery gets discharged and the date and time settings may be cleared from the memory. In that case, charge the rechargeable battery and then set the date and time again (p. 140).

MENU button

▲/▼/◀/▶/SET buttons

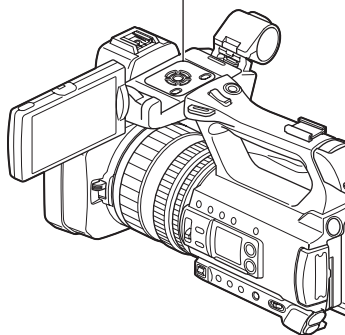
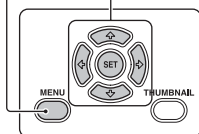

When you set the date and time again, press the MENU button, and select  (OTHERS) → [CLOCK SET].

- 1 Select your area using the ▲/▼/◀/▶/SET button, then press the button.

## Step 4: Turning on the camcorder and setting the date and time (Continued)

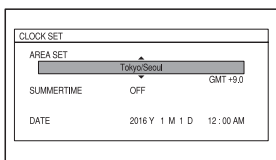

- 2** Set [SUMMERTIME], [Y] (year), [M] (month), [D] (day), hour and minute, using the  $\uparrow/\downarrow/\leftarrow/\rightarrow$ /SET button, then press the button.

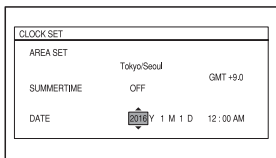

The clock starts.

- Set [SUMMERTIME] to [ON] to move the time forward 1 hour.
- You can set any year up to the year 2037.
- Midnight is indicated as 12:00 AM, and noon as 12:00 PM.

### Tip

- The date and time are automatically recorded on the selected memory card, and can be displayed during playback (p. 109).

## Step 5: Adjusting the LCD screen and viewfinder

### Using the LCD screen

The LCD screen can be rotated in the range as illustrated below, allowing a person other than the camera operator to see the image.

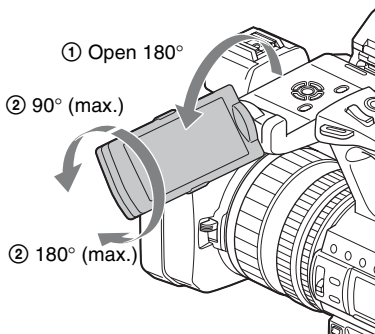

### Using the viewfinder

The display switches to viewfinder display automatically whenever your eye is near the eye sensor on the side of the viewfinder. When you move your eye away from the viewfinder, the display switches back to the LCD screen.

You can adjust the angle of the viewfinder to suit your shooting style.

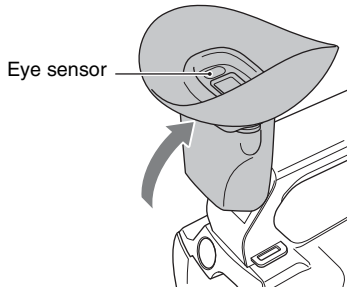



**Note**

The LCD screen and the viewfinder do not operate at the same time.

**Adjusting the viewfinder focus****Diopter adjustment dial**

Move it until the picture becomes clear.

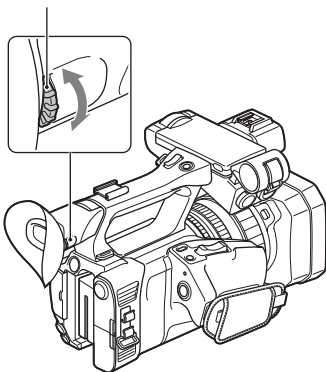
**Note**

- Some primary colors may become visible in the viewfinder if you change your line of sight, but this is not a malfunction. These colors are not recorded onto the memory cards.

**When the picture in the viewfinder is hard to see**

If you cannot see the picture in the viewfinder clearly under bright circumstances, use the supplied large eyecup. To attach the large eyecup, stretch it slightly and fit it over the groove of the eyecup attached to the camcorder. You can attach the large eyecup facing either the right or left side.

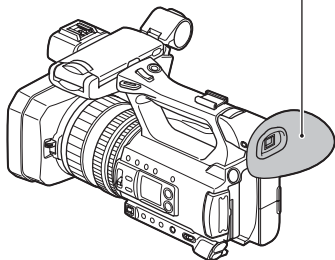
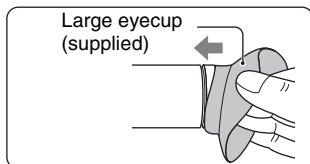
**Note**

- Do not remove the eyecup attached to the camcorder.

**Switching between LCD screen display and viewfinder display****Using the menu**

Set [VF/LCD PANEL] (p. 109) in the  (DISPLAY SET) menu to one of the following.

- To use only the LCD screen, select [LCD PANEL].  
 appears on the screen.
- To switch automatically between the LCD screen and viewfinder, select [AUTO]. When [AUTO] is selected, the display switches to viewfinder display automatically whenever your eye is near the eye sensor on the side of the viewfinder. When you move your eye away from the viewfinder, the display switches back to the LCD screen.

**Tips**

- The default setting of [VF/LCD PANEL] is [AUTO].

## Step 5: Adjusting the LCD screen and viewfinder (Continued)

- The eye sensor will be activated if the eye sensor is blocked, even if you are not looking into the viewfinder.

### Using buttons

Press the ASSIGN6/VF/LCD PANEL button.

The [VF/LCD PANEL] menu setting changes with each press of the button.

This allows you to switch instantly, without having to access the menu.

# Step 6: Inserting a memory card

## Supported memory cards

File format	Supported memory cards
AVCHD	SD, SDHC, SDXC memory cards (Class 4 or U1 or faster) Memory Stick PRO Duo (Mark2), Memory Stick PRO-HG Duo
AVCHD (Slow & Quick Motion)	SDHC, SDXC memory cards (Class 10 or U1 or faster)
XAVC HD	SDXC memory cards (Class 10 or U1 or faster)
XAVC HD (Slow & Quick Motion, High Frame Rate)	SDXC memory cards (U3)
XAVC HD (Proxy simultaneous recording)	SDXC memory cards (Class 10 or U1 or faster)* <sup>1</sup>
XAVC QFHD	SDXC memory cards (Class 10 or U1 or faster)* <sup>2</sup>
XAVC QFHD (Proxy simultaneous recording)	SDXC memory cards (U3)
MPEG HD422/420	SDXC memory cards (Class 10 or U1 or faster)
MPEG HD422/420 (Slow & Quick Motion)	SDXC memory cards (U3)
MPEG HD422/420 (Proxy simultaneous recording)	SDXC memory cards (Class 10 or U1 or faster)* <sup>3</sup>

\*<sup>1</sup> SDXC memory cards (U3) are required for simultaneous XAVC HD (50 Mbps) and proxy (9 Mbps) recording.

\*<sup>2</sup> SDXC memory cards (U3) are required to record at 100 Mbps.

\*<sup>3</sup> SDXC memory cards (U3) are required for simultaneous MPEG HD 422 and proxy (9 Mbps) recording.

### Notes

- Operation with all memory cards is not assured.
- See page 126 for the recording time of memory cards.
- Movies recorded on SDXC memory cards can be imported to or played back on other equipment, such as a computer or A/V device, by connecting the camcorder to the equipment with the USB cable. However, the equipment must support the exFAT file system used for SDXC memory cards. Confirm in advance that the connecting equipment is supporting the exFAT file system. If you connect equipment not supporting the exFAT file system and the format screen appears, do not perform the format. All the data recorded will be lost.

## Step 6: Inserting a memory card (Continued)

Open the cover, and insert the memory card with the notched edge in the direction as illustrated until it clicks into place.

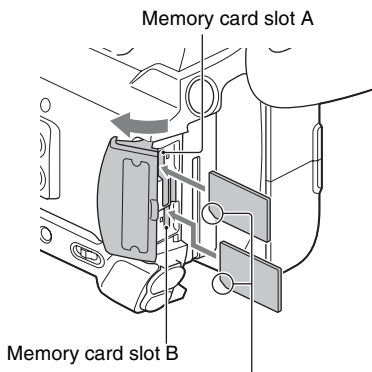

Note the direction of the notched corner.

- If you insert a memory card into the slot in the wrong direction, the memory card, the memory card slot, or image data may be damaged.
- Memory card slot A accepts both “Memory Stick PRO Duo” and SD cards. Memory card slot B accepts SD cards only.

### Selecting the memory card slot to be used for recording

Press the SLOT SEL button to change which slot is selected for recording. You can confirm the selected slot on the screen.

SLOT SEL button

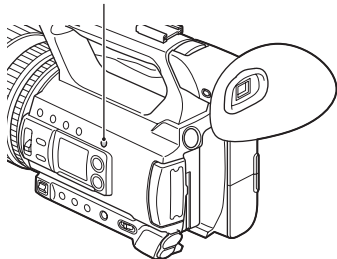

#### Notes

- You can only select a slot that already has a memory card inserted.
- When recording to a memory card, you cannot switch the slot even if you press the SLOT SEL button.

#### Tip

- When only one slot has a memory card inserted, the slot that has the memory card is selected automatically.

### To eject a memory card

Lightly push the memory card once.

#### Notes

- If “The image database file is corrupted. The media must be restored to use again.” appears, format the memory card (p. 96).
- When inserting or ejecting the memory card, be careful of the memory card popping out and dropping.

# Recording

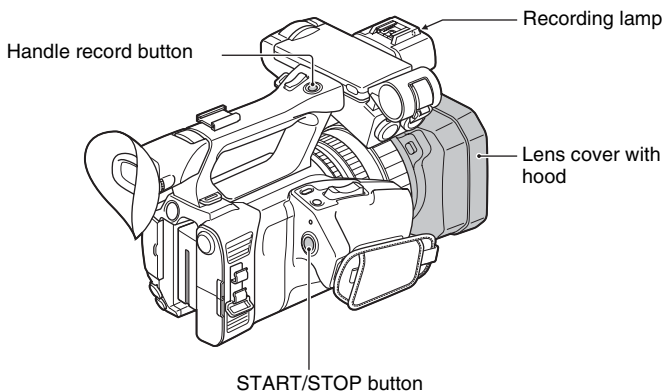

## Recording

Your camcorder records movies on memory cards. The factory setting for recording is XAVC HD. Do the following steps to record.

- 1** Open the shutter of the lens cover with hood.

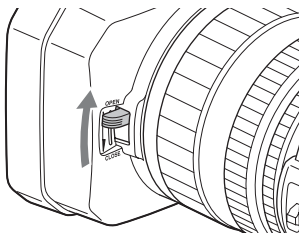

### 2 Turn the ON/STANDBY switch to ON (I).

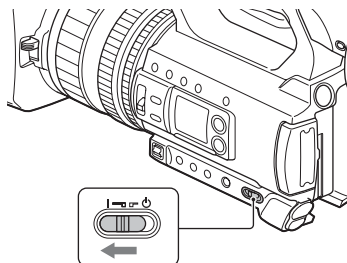

### 3 Press the START/STOP button (or the handle record button) to start recording.

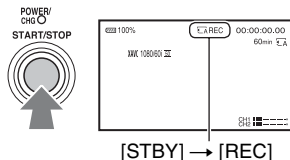

The recording lamps light up during recording.

To stop recording, press the START/STOP button (or the handle record button) again.

#### ⚡ Notes

- When the access lamp is lit or flashing in red, your camcorder is reading or writing data. Do not shake or apply strong force to your camcorder, do not turn the power off, and do not remove the memory card, battery pack or the AC Adaptor. The image data may be destroyed.
- See page 126 about the recording time of movies.
- If a movie file size exceeds 2 GB while recording in AVCHD format, the camcorder automatically divides the file and creates a new one.
- When recording in XAVC/MPEG HD, recording stops automatically when the recorded file reaches 6 hours duration.
- The menu settings, the picture profile settings, and the settings made by the FULL AUTO button are stored in your camcorder when you set the ON/STANDBY switch to STANDBY (O). The POWER/CHG lamp flashes while the settings are being stored.

## 💡 Tips

- For details about changing the screen display during recording, see page 68.
- For details about screen display during recording, see page 17.
- The recording lamps can be set to stay off ([REC LAMP], p. 113).

## Continuous recording on the memory cards (Relay Rec)

Insert memory cards each in both slots A and B so the camcorder switches memory card A (or B) just before the remaining space on the other one runs out, and continues recording on the next memory card automatically.

Do the following setting before recording.

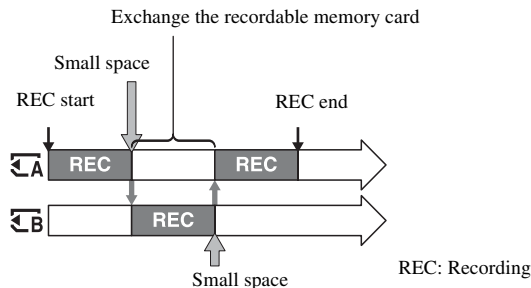

Press MENU → select  $\rightleftarrows$  (REC/OUT SET) → [REC SET] → [SIMUL/RELAY REC] → [RELAY REC] with the  $\uparrow/\downarrow/\leftarrow/\rightarrow$ /SET button.



## 📌 Notes

- Do not eject the memory card that is currently being used for recording. When replacing a memory card while recording, replace only the one in the slot whose access lamp is off.
- Even if you press the SLOT SEL button, while recording movies, you cannot switch the slot currently being used.
- When the remaining recording time of the memory card being used is less than 1 minute and the other slot has a recordable memory card inserted, [ $\overline{A} \rightarrow \overline{B}$ ] or [ $\overline{B} \rightarrow \overline{A}$ ] appears on the camcorder screen. The indicator turns off when the memory card is switched.
- If you start recording on a memory card with the remaining recording time of less than 1 minute, the camcorder may not be able to relay-record. To relay-record without failing, make sure that the memory card has more than 1 minute when you start recording.
- Seamless playback of relay-recorded movies with this camcorder is not possible.
- You can combine relay-recorded movies using application software (p. 20).
- The maximum recording time using relay recording is 6 hours for XAVC/MPEG HD and 13 hours for AVCHD. Recording stops automatically when the maximum recording time elapses.

### Recording movies using both memory card A and B (Simul Rec)



You can record movies on both memory card A and memory card B simultaneously. Press MENU → select  (REC/OUT SET) → [REC SET] → [SIMUL/RELAY REC] → [SIMULTANEOUS REC] with the /SET button.









### Changing the setting of the START/STOP button and handle record button

When using SIMULTANEOUS REC, you can start and stop recording on different memory cards by using the START/STOP button and the handle record button. In the default setting, movies are recorded on both the memory card A and B at the same time when either record button is pressed.

- REC BUTTON:  
- HANDLE REC BUTTON:  

#### To change the setting

Press MENU → select  (REC/OUT SET) → [REC SET] → [REC BUTTON SETTING] with the /SET button.

REC BUTTON SETTING setting	Button and memory card
REC BUTTON:   HANDLE REC BUTTON:  	Recording on both the memory card A and the memory card B starts and stops at the same time when either record button is pressed.
REC BUTTON:  HANDLE REC BUTTON: 	Recording on the memory card A starts and stops when the START/STOP button is pressed, and on the memory card B when the handle record button is pressed.
REC BUTTON:  HANDLE REC BUTTON: 	Recording on the memory card B starts and stops when the START/STOP button is pressed, and on the memory card A when the handle record button is pressed.



## Adjusting the zoom

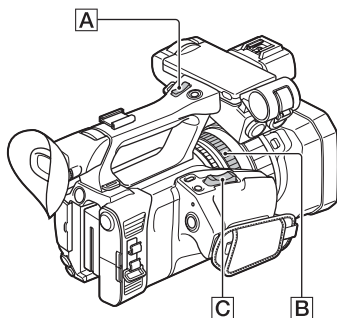

### Adjusting the zoom with the power zoom lever

Press the zoom lever **C** slightly to zoom slowly, and press it further to zoom more quickly.

#### 💡 Tips

- When focusing, the minimum distance required between the camcorder and the subject is about 1 cm (about 13/32 in.) for wide angle and about 1 meter (about 39 3/8 in.) for telephoto.
- The focus may not be adjusted at certain zoom positions if the subject is within 1 meter (about 39 3/8 in.) from your camcorder.
- Keep your finger on the power zoom lever **C**. If you move your finger off the power zoom lever **C**, the operation sound of the power zoom lever may also be recorded.
- You can select the type of zoom operation for the zoom lever ([ZOOM TYPE], page 100).

### Adjusting the zoom with the handle zoom

Press the handle zoom lever **A** to zoom in or out.

#### 💡 Tip

- You can turn the handle zoom function on/off, and change the zoom operation speed ([HANDLE ZOOM], page 100).

### Adjusting the zoom with the zoom ring

You can zoom at the desired speed by turning the zoom ring **B**. Fine adjustment is also possible.

#### 🔔 Note

- Turn the zoom ring **B** at a moderate speed. If you turn it too fast, the zoom may lag behind the zoom ring rotation, or the operation sound of the zoom may also be recorded.

# Adjusting the focus

You can adjust the focus manually for different recording conditions.

Use this function in the following cases.

- To record a subject behind a window covered with raindrops.
- To record horizontal stripes.
- To record a subject with little contrast between the subject and its background.
- When you want to focus on a subject in the background.
- To record a stationary subject using a tripod.

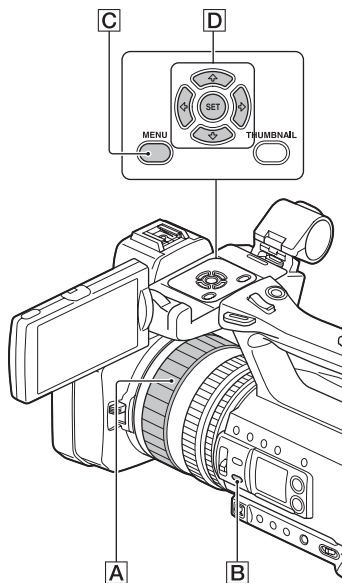

- 1 During recording or standby, press the FOCUS AUTO/MAN button [B] to set the focus to manual.**

appears.

- 2 Turn the focus ring [A] to adjust the focus.**

changes to when the focus cannot be adjusted any farther, and changes to when the focus cannot be adjusted any closer.

## To adjust automatically

Press the FOCUS AUTO/MAN button [B] to set the focus to automatic.

disappears and the automatic focus adjustment is restored.

## Tips

- The focal length information (the distance at which the subject is in focus; for when it is dark and hard to adjust the focus) appears for about 3 seconds in the following cases.
  - When you press the FOCUS AUTO/MAN button [B] to set the focus to manual and appears on the LCD screen.
  - When you rotate the focus ring [A] while is displayed.
- You can switch the focal length information between meters and feet ([FOCUS DISPLAY], p. 109).

## Focusing using the focus magnifier

The selected area on the LCD screen is magnified and displayed. It is easier to confirm the focus setting during manual focusing.

[FOCUS MAGNIFIER] is assigned to the ASSIGN5/FOCUS MAG button (p. 62).

## Press the ASSIGN5/FOCUS MAG button.

The center of the screen is magnified. The setting changes with each press of the button.

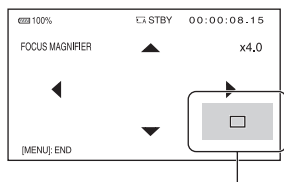

Enlarged display position

You can adjust the enlarged display position with the  $\uparrow/\downarrow/\leftarrow/\rightarrow$  buttons on the camcorder. Press the SET button to set the enlarged display position back to the center.

### Note

- Even though the image appears expanded on the LCD screen, the recorded image is not expanded.

### Tip

- You can change the magnification ratio with [FOCUS MAG RATIO] (p. 108).

## Focusing on a detected face (Face detection)

The camcorder detects the face and focuses on it (The default setting is [OFF]). [FACE DETECTION] is available only with automatic focus.

### 1 Press the MENU button $\square$ .

### 2 Select $\square$ (CAMERA SET) $\rightarrow$ [FACE DETECTION] $\rightarrow$ [ON] with the $\uparrow/\downarrow/\leftarrow/\rightarrow$ /SET button $\square$ .

When the faces are detected, frames appear on the LCD screen.

### 3 Press the $\uparrow/\downarrow/\leftarrow/\rightarrow$ /SET button $\square$ , move the selection cursor (orange colored frame) to select the priority face, then press the button again.

Selection cursor (orange colored frame)



Priority face frame (double frame)

The frame on the priority face changes to a double frame.

## To cancel the priority face

Move the selection cursor (orange colored frame) onto the frame (double frame) on the priority face, using the  $\uparrow/\downarrow/\leftarrow/\rightarrow$ /SET button  $\square$ , then press the button.

### Notes

- Faces may not be detected depending on the recording environment, the condition of the subject or the settings.
- You may not be able to get the proper effect in some recording environments. If this happens, set [FACE DETECTION] to [OFF].
- [FACE DETECTION] is grayed out when using clear image zoom, digital zoom, or the nightshot function.

## Adjusting the focus (Continued)

- Face detection is not available in the following cases.
  - When streaming is ON during XAVC HD/QFHD recording
  - When HDMI output or proxy recording is ON during XAVC QFHD recording
- For details about limitations of face detection, see “Function limitations when recording” (p. 129) and “Slow & Quick Motion and High Frame Rate recording limitations” (p. 130).

### **Tips**

- You can assign this function to an ASSIGN button (p. 62).
- To make it easy to detect faces, record under the following conditions:
  - Record in a moderately bright place.
  - Do not obscure the face with a hat, mask, sunglasses, etc.
  - Face the front of the camera.

# Selecting the file format and recording format

## Supported file formats

The following five file formats are supported (default setting in bold).

- XAVC QFHD (4K mode)
- **XAVC HD**
- MPEG HD 422
- MPEG HD 420
- AVCHD

## Setting the file format and recording format

You can select the file format in [FILE FORMAT] and the recording format (bit-rate, image size, frame rate, and scanning system) in [REC FORMAT].

**1** Press the **MENU** button.

**2** Press the **↔/↔/↔/↔/SET** button to select **↔** (REC/OUT SET) → [REC SET] → [FILE FORMAT] → the desired format.

**3** Select **↔** (REC/OUT SET) → [REC SET] → [REC FORMAT] → a desired format with the **↔/↔/↔/↔/SET** button.

### XAVC QFHD (4K mode)

(Default setting in bold)

60i	50i
2160/30p 100Mbps	2160/25p 100Mbps
<b>2160/30p 60Mbps</b>	<b>2160/25p 60Mbps</b>
2160/24p 100Mbps	–
2160/24p 60Mbps	–

- Image size: 2160 (3840×2160)

- Frame rate: 30/25/24
- Scanning system: p (progressive)
- Bit rate: 100 Mbps/60 Mbps

### XAVC HD

(Default setting in bold)

60i	50i
1080/60p 50Mbps	1080/50p 50Mbps
1080/60p 35Mbps	1080/50p 35Mbps
<b>1080/60i 50Mbps</b>	<b>1080/50i 50Mbps</b>
1080/60i 35Mbps	1080/50i 35Mbps
1080/60i 25Mbps	1080/50i 25Mbps
1080/30p 50Mbps	1080/25p 50Mbps
1080/30p 35Mbps	1080/25p 35Mbps
1080/24p 50Mbps	–
1080/24p 35Mbps	–
720/60p 50Mbps	720/50p 50Mbps

- Image size: 1080 (1920×720) / 720 (1280×720)
- Frame rate: 60/50/30/25/24
- Scanning system: p (progressive) / i (interlaced)
- Bit rate: 50 Mbps/35 Mbps/25 Mbps

### MPEG HD 422

(Default setting in bold)

60i	50i
<b>1080/60i 50Mbps</b>	<b>1080/50i 50Mbps</b>
1080/30p 50Mbps	1080/25p 50Mbps
1080/24p 50Mbps	–
720/60p 50Mbps	720/50p 50Mbps

- Image size: 1080 (1920×720) / 720 (1280×720)
- Frame rate: 60/50/30/25/24
- Scanning system: p (progressive) / i (interlaced)
- Bit rate: 50 Mbps

### MPEG HD 420

(Default setting in bold)

60i	50i
<b>1080/60i HQ</b>	<b>1080/50i HQ</b>
1080/30p HQ	1080/25p HQ
1080/24p HQ	–

## Selecting the file format and recording format (Continued)

60i	50i
1080/60i (1440) HQ	1080/50i (1440) HQ
720/60p HQ	720/50p HQ

- Image size: 1080 (1920×1080) (1440×1080) / 720 (1280×720)
- Frame rate: 60/50/30/25/24
- Scanning system: p (progressive) / i (interlaced)
- Bit rate: HQ 35 Mbps

### AVCHD

(Default setting in bold)

60i	50i
1080/60p PS	1080/50p PS
<b>1080/60i FX</b>	<b>1080/50i FX</b>
1080/60i FH	1080/50i FH
1080/30p FX	1080/25p FX
1080/30p FH	1080/25p FH
1080/24p FX	–
1080/24p FH	–
720/60p FX	720/50p FX
720/60p FH	720/50p FH
720/60p HQ	720/50p HQ

- Image size: 1080 (1920×1080) / 720 (1280×720)
- Frame rate: 60/50/30/25/24
- Scanning system: p (progressive) / i (interlaced)
- Bit-rate  
PS: max. 28 Mbps  
FX: max. 24 Mbps  
FH: approx. 17 Mbps (average)  
HQ: approx. 9 Mbps (average)

### Frame rate when [60i] is selected

The frame rate displayed on the LCD screen differs from the actual frame rate.

Frame rate on the LCD screen	Actual frame rate
24	23.98
30	29.97
60	59.94

## Setting the output destination when recording in 4K mode

You can select the output for the video signal when recording in XAVC QFHD.

**1** Press the **MENU** button.

**2** Select **↔ (REC/OUT SET)** → **[VIDEO OUT]** → **[OUTPUT SELECT]** → **[QFHD REC OUTPUT]** with the **↔/↔/↔/SET** button.

**3** Select **[VF/LCD PANEL]** or **[EXTERNAL OUTPUT]** using the **↔/↔/↔/SET** button, then press the button.

Selection values:

VF/LCD PANEL: Viewfinder/LCD screen

EXTERNAL OUTPUT: External output selected in [OUTPUT SELECT].

The picture being recorded is not displayed on the viewfinder/LCD screen when [QFHD REC OUTPUT] is set to [EXTERNAL OUTPUT].

### ⚙ Notes

- The picture is output to the viewfinder/LCD screen when recording using the following functions, even when set to [EXTERNAL OUTPUT].
  - Recording to media while live streaming and streaming distribution
- The [QFHD REC OUTPUT] settings are enabled only when [FILE FORMAT] is set to [XAVC QFHD] in the REC/OUT SET menu.
- Any one of the following functions can be used while recording in XAVC QFHD.
  - External output while recording

- Face detection function
  - Proxy recording (however, not supported when all the conditions below are met)
    - When REC/OUT SET → [REC SET] → [REC FORMAT] is set to 100Mbps
    - When REC/OUT SET → [REC SET] → [SIMUL/RELAY REC] is set to [OFF]
- 

# Proxy recording

This function allows you to simultaneously record a low bitrate proxy file at the same time as recording the high bitrate original file movie.

## Notes on proxy recording

### Function limitations when proxy recording

Some functions, such as the file format, on the camcorder may be unavailable when proxy recording. For details, see “Function limitations when recording” (p. 129).

### Proxy recording supported formats

Proxy recording is supported when the file format [FILE FORMAT] is set to other than AVCHD.

There are also limitations on the size of the original file movie and the proxy file movie.



For details, see “Proxy recording supported formats” (p. 131).

### Supported media for proxy recording

For details, see “Supported memory cards” (p. 27).

## Proxy recording

**1** Press the MENU button.

**2** Select  (REC/OUT SET) → [REC SET] → [PROXY REC MODE] → [ON/OFF] → [ON] with the /↑/↓/←/→/SET button.

 appears on the screen.

- 3 Select the desired image size in  $\Rightarrow$  (REC/OUT SET)  $\rightarrow$  [REC SET]  $\rightarrow$  [PROXY REC MODE]  $\rightarrow$  [SIZE]  $\rightarrow$  with the  $\uparrow/\downarrow/\leftarrow/\rightarrow$ /SET button.

- 4 Press the record button to begin recording.

### Note

- The camcorder can no longer record when the maximum number of XAVC/MPEG HD files is reached (600).

### About proxy recording files

- For details about the storage location of proxy recording files, see “File/folder structure on the recording media” (p. 135).
- Proxy files cannot be played on the camcorder. [Px] appears on the thumbnail of the original file.
- A proxy file is also deleted/protected when the corresponding original file is deleted/protected.

## Adjusting the brightness

You can adjust the image brightness by adjusting the iris, gain or shutter speed, or by adjusting the light volume with the ND filter switch [B].

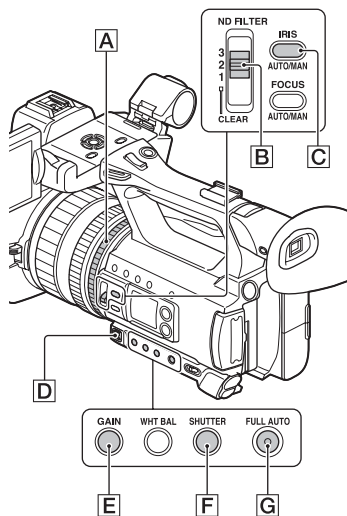

### Note

- When you set the FULL AUTO button [G] on, the iris, gain, shutter speed, and white balance are adjusted automatically. You cannot adjust any of them manually.

## Adjusting the iris

This is handy for making the background blurred or sharp.

- 1 Press the FULL AUTO button [G] to set auto mode off.

The FULL AUTO button lamp turns off.

- 2 Press the IRIS AUTO/MAN button [C] to set the iris to manual.

The [A] next to the iris value disappears.





Iris value

### 3 Turn the iris ring **[A]** to adjust the value.

The volume of the light increases the more that you open the aperture (decreasing F value). The volume of the light decreases the more that you close the aperture (increasing F value).

### To temporarily adjust the iris automatically

If the [IRIS PUSH AUTO] function has been assigned to an ASSIGN button (p. 62), press and hold the button to adjust the iris automatically.

### To adjust automatically

Press the IRIS AUTO/MAN button **[C]** when the **[A]** mark beside the iris value is not displayed.

The iris value disappears or **[A]** appears next to the iris value.

### Adjusting the gain

You can use this if you do not want to increase the value by AGC (automatic gain control).

### 1 Press the FULL AUTO button **[G]** to set auto mode off.

The FULL AUTO button lamp turns off.

### 2 Press the GAIN button **[E]**.

The **[A]** next to the gain value disappears, and the gain value is highlighted.



Gain value

### 3 Adjust the value using the manual lever **[D]**.

Setting values:

33dB, 30dB, 27dB, 24dB, 21dB, 18dB, 15dB, 12dB, 9dB, 6dB, 3dB, 0dB (default), -3dB

### To adjust automatically

Press the GAIN button **[E]** while the gain value is highlighted.

The gain value disappears, or **[A]** appears next to the gain value.

### Adjusting the shutter speed

You can adjust and fix the shutter speed manually. You can make a moving subject look still or emphasize the movement of a subject by adjusting the shutter speed.

### 1 Press the FULL AUTO button **[G]** to set auto mode off.

The FULL AUTO button lamp turns off.

### 2 Press the SHUTTER button [F].

The **A** next to the shutter speed value disappears, and the shutter speed value is highlighted.

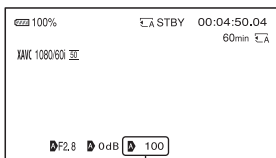

Shutter speed value

### 3 Adjust the value using the manual lever [D].

Selection range:

When [60i] is selected:

You can select from 1/8 to 1/10000 (1/6 to 1/10000 when shooting with 24p).

When [50i] is selected:

You can select from 1/6 to 1/10000.

The denominator of the set shutter speed appears on the LCD screen. For example, [100] appears on the LCD screen when you set the shutter speed to 1/100 second. The larger the value on the LCD screen is, the faster the shutter speed is.

#### Tips

- It is difficult to focus automatically at a lower shutter speed. Manual focusing with your camcorder attached to a tripod is recommended.
- When recording under fluorescent lamps, sodium lamps, or mercury lamps, the picture may flicker or change colors, or may have horizontal bands of noise. You may be able to improve the situation by adjusting the shutter speed to 1/50 if the power frequency of your area is 50 Hz, or 1/60 in a 60 Hz area.

- You can switch the shutter speed display between seconds and degrees ([SHUTTER DISPLAY], p. 109).

### To adjust automatically

Press the SHUTTER button [F] while the shutter speed value is highlighted. The shutter speed value disappears, or **A** appears next to the shutter speed value.

### Adjusting the light level (ND filter)

You can record a subject clearly by using the ND filter switch [B] when the recording environment is too bright.

The ND filters 1, 2 and 3 reduce the volume of light to about 1/4, 1/16 and 1/64, respectively.

If **ND1** flashes during the iris automatic adjustment, set the ND filter to 1. If **ND2** flashes during the iris automatic adjustment, set the ND filter to 2. If **ND3** flashes during the iris automatic adjustment, set the ND filter to 3. The ND filter indicator will stop flashing and remain on the screen.

If **NDOFF** flashes, set the ND filter [B] to “CLEAR.” The ND filter icon will disappear from the screen.

#### Notes

- If you change the ND filter switch [B] during recording, the movie and sound may become distorted.
- When adjusting the iris manually, the ND filter icon does not flash even if the light volume should be adjusted with the ND filter.
- If the camcorder cannot detect the ND filter position (CLEAR/1/2/3), **ND** flashes on the screen. Make sure that the ND filter is set correctly.

#### Tip

- While recording a bright subject, diffraction may occur if you close the aperture further down, resulting in a fuzzy focus (this is a common phenomenon with video cameras). The



# Adjusting the color tone

ND filter switch **[B]** suppresses this phenomenon and gives better recording results.

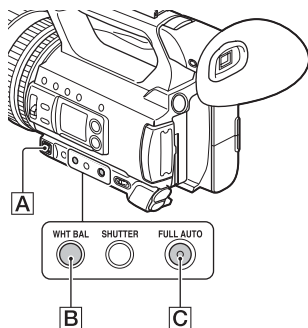
## Adjusting the white balance



You can adjust and fix the white balance according to the lighting conditions of recording environment.

You can store white balance values in memory A (  A) and memory B (  B), respectively. Unless a white balance is readjusted, values will remain even after the power has been turned off.

When you select PRESET, [OUTDOOR], [INDOOR] or [MANU WB TEMP] is selected, according to which one you previously set with [WB PRESET] in the  (CAMERA SET) menu.

### Tip

- You can assign [WB PRESET] to an ASSIGN button (p. 62).

---

## 1 Press the FULL AUTO button **[C]** to set auto mode off.

The FULL AUTO button lamp turns off.

---

## 2 Press the WHT BAL button **[B]**.

The white balance value is highlighted.

### 3 Select PRESET, A, or B using the manual lever [A].

#### ■ Setting the A/B value

Select A or B for recording with the white balance setting stored in memory A or B.

#### ■ To use the PRESET value of white balance

Select (CAMERA SET) → [WB PRESET] and select a desired setting.

Setting values	Example of recording conditions
Outdoor ([OUTDOOR])	<ul style="list-style-type: none"> <li>When recording a night scene, neon lighting, fireworks, etc.</li> <li>When recording a sunrise, sunset, etc.</li> <li>Under daylight fluorescent lamp</li> </ul>
Indoor ([INDOOR])	<ul style="list-style-type: none"> <li>Where lighting conditions change, such as at a party place, etc.</li> <li>Under video light, such as in a studio, etc.</li> <li>Under a sodium or mercury lamp</li> </ul>
Color temperature setting ([MANU WB TEMP])	<ul style="list-style-type: none"> <li>You can set a desired color temperature between 2300K and 15000K with  (CAMERA SET) → [WB TEMP SET] (default setting is 6500K).</li> </ul>

### To save the adjusted white balance value in memory A or B

- 1 Press the FULL AUTO button [C] to set auto mode off.

- 2 Press the WHT BAL button [B] to highlight the white balance value.
- 3 Select A () or B () using the manual lever.
- 4 Press the MENU button.
- 5 Press the ////SET buttons to select (CAMERA SET) → [WB SET].
- 6 Frame a white object such as a piece of paper that fills the screen under the same lighting conditions as your subject.
- 7 Press the SET button.  
The adjusted value is stored in A or B. The stored color temperature appears for about 3 seconds.

#### Tip

- [WB SET] is assigned to the ASSIGN1/WB SET button. The adjusted value is stored by pressing the ASSIGN1/WB SET button when the shooting screen is displayed, instead of performing steps 4 to 7.

#### Note

- When a white balance adjustment value has not been obtained successfully, A or B starts flashing slowly. Adjust the subject appropriately and set the shutter speed to auto or around 1/60 (60i models)/1/50 (50i models), then try adjusting the white balance again.

### To restore automatic adjustment

Press the WHT BAL button [B].

#### Note

- When you turn the FULL AUTO button [C] on, all other manual adjustments (iris, gain, and shutter speed) are also released.

# Audio setup

The jacks, switches and dials shown below allow you to set the sound that is recorded. See page 9 for details about connecting a microphone.

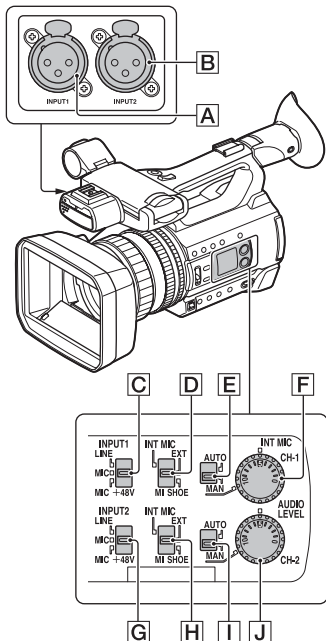

## External audio input and selection

- A:** INPUT1 jack
- B:** INPUT2 jack
- C:** INPUT1 (LINE/MIC/MIC+48V) switch
- G:** INPUT2 (LINE/MIC/MIC+48V) switch

## Audio source switches

- D:** CH-1 (INT MIC/EXT/MI SHOES) switch
- H:** CH-2 (INT MIC/EXT/MI SHOES) switch

## Audio level controls

- E:** AUTO/MAN (CH-1) switch
- I:** AUTO/MAN (CH-2) switch
- F:** AUDIO LEVEL (CH-1) dial
- J:** AUDIO LEVEL (CH-2) dial

## Recording sound from the internal microphone

You can record sound in stereo using the camcorder's internal microphone.

### Internal microphone

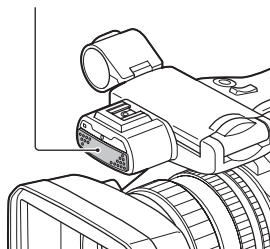

- 1** Set the CH-1 (INT MIC/EXT/MI SHOES) switch **D** and CH-2 (INT MIC/EXT/MI SHOES) switch **H** to "INT MIC."

## 💡 Tips

- If the audio level is too low, set [INT MIC SENS] to [HIGH].
- To reduce wind noise, set [INT MIC WIND] to [ON].
- If the internal microphone is selected for both channels 1 and 2 (CH-1: INT MIC, CH-2: INT MIC), the sound that is output from the headphones during recording and standby will have weaker stereo effect than the sound that is actually recorded.

### Recording sound from an external audio device

Use the following procedure if using a microphone or external audio device.

#### 1 Select the audio input source.

- Set the INPUT1/INPUT2 (LINE/MIC/MIC+48V) switch (**C** or **G**) based on the device connected to INPUT1 jack **A**/INPUT2 jack **B**.
- To record using a microphone, select “MIC” or “MIC+48V.” See page 9 for details about connecting a microphone.

Connected device	Switch position
External audio device (such as mixer)	LINE
Dynamic microphone or microphone with built-in battery	MIC
+48V powered (phantom power) microphone	MIC+48V

#### Notes

- If the switch is set to MIC+48V and you connect a device that is not compatible with +48V power, it may damage the connected device. Check the switch before connecting the device.
- To prevent unwanted noise when no audio device is connected to the INPUT1 or INPUT2 jack, set the INPUT1/INPUT2 (LINE/MIC/MIC+48V) switch (**C** or **G**) to “LINE.”

#### 2 Set the CH-1 (INT MIC/EXT/MI SHOE) switch **D** and CH-2 (INT MIC/EXT/MI SHOE) switch **H** to “EXT.”

- If [INPUT CH SELECT] is set to [INPUT1/INPUT2] in the [XLR SET] menu, the audio input on the INPUT1 and INPUT2 jacks are recorded for CH1 and CH2, respectively.

- If [INPUT CH SELECT] is set to [INPUT1/INPUT1] in the [XLR SET] menu, the audio input on the INPUT1 jack is recorded to both CH1 and CH2.

[XLR SET] > [INPUT CH SELECT] setting	Sound recorded to CH1 and CH2
INPUT1/ INPUT2	INPUT1 → CH1 INPUT2 → CH2
INPUT1/ INPUT1	INPUT1 → CH1 ↓ CH2

#### 3 Set the input level of the external audio device.

When the INPUT1/INPUT2 (LINE/MIC/MIC+48V) switch (**C** or **G**) is set to “MIC” or “MIC+48V,” the XLR microphone input level can be set using [INPUT1 TRIM]/[INPUT2 TRIM] in the menu (p. 106). Adjust the setting based on the sensitivity of the microphone.

#### Tip

- When using a stereo microphone that has two XLR plugs, connect the left channel (L) to the INPUT1 jack **A** and the right channel (R) to the INPUT2 jack **B**, then set the CH-1 (INT MIC/EXT/MI SHOE) switch **D** and CH-2 (INT MIC/EXT/MI SHOE) switch **H** to “EXT.”

### Recording sound from a Multi Interface Shoe compatible microphone (sold separately)

You can record sound in stereo using a Multi Interface Shoe compatible microphone.

**1** Connect the Multi Interface Shoe compatible microphone (sold separately) to the Multi Interface Shoe.

**2** Set the CH-1 (INT MIC/EXT/MI SHOE) switch **[D]** and CH-2 (INT MIC/EXT/MI SHOE) switch **[H]** to “MI SHOE.”

### Setting the audio recording level

When the CH-1 and CH-2 switches are both set to “INT MIC,” both the left and right channels are adjusted by the CH-1 switch/dial.

**1** Set the AUTO/MAN switch (**[E]** or **[I]**) of the channel (CH-1 or CH-2) to adjust to “MAN.”

**M<sub>2</sub>** appears on the screen.

**2** Turn the AUDIO LEVEL dial (**[F]** or **[J]**) of the channel (CH-1 or CH-2) to adjust the audio level.

Use headphones or an audio level meter to check that the audio level is appropriate.

#### To restore automatic adjustment

Set the AUTO/MAN switch (**[E]** or **[I]**) of the manually adjusted channel (CH-1 or CH-2) to “AUTO.”

### Setting the headphone sound

**1** Press the MENU button.

**2** Select **[MUSIC]** (AUDIO SET) → **[HEADPHONE OUT]** with the **↔/↔** **↔/↔**/SET button.

**3** Select one of the following.

[HEADPHONE OUT] setting	Headphones audio output
STEREO	CH-1 is output on L (left) and CH-2 is output on R (right).
MIX MONO	CH-1 and CH-2 are mixed and output on L (left) and R (right) (monaural).
CH1	CH-1 is output on L (left) and R (right).
CH2	CH-2 is output on L (left) and R (right).

# Useful functions

## Selecting suitable settings automatically (auto mode setting)

You can make optimal recordings in various situations.

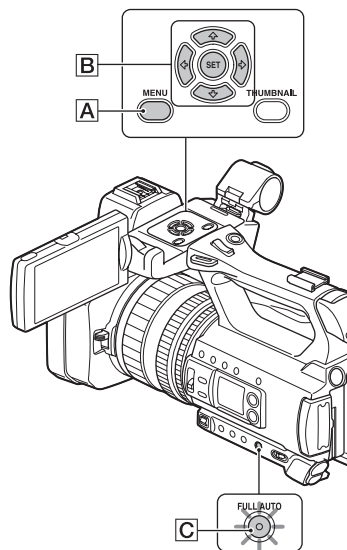

### 1 Press the FULL AUTO button **C** to set auto mode on.

The FULL AUTO button lamp (green) turns on.

### 2 Press the MENU button **A**.



### 3 Select (CAMERA SET) → [AUTO MODE SET] with the /SET button **B**.







### 4 Press the /SET button **B**, select [AUTO], [INTELLIGENT AUTO], or [SCENE SELECTION], and press the button again.



#### Notes

- When you select [INTELLIGENT AUTO], [STEADYSHOT] is set to [ACTIVE], and the angle of view shifts 1.08 times toward the telephoto side.
- [INTELLIGENT AUTO] and [SCENE SELECTION] are not supported for XAVC QFHD.



#### Scenes detected by INTELLIGENT AUTO



Face detection:  (Portrait),  (Baby)

Scene detection:  (Backlight),  (Landscape),  (Night Scene),  (Spotlight),  (Low Light),  (Macro)





Camera-shake detection:  (Walk),  (Tripod)

#### To use [SCENE SELECTION]

- ① Press the MENU button **A**, press the /SET button **B** and select  (CAMERA SET) → [SCENE SELECTION SET], then press the button again.
- ② Press the /SET button **B**, select the desired setting, then press the button again.

Setting values	Recording conditions
 Night Scene* ([NIGHT SCENE])	Shoots a night view with a proper exposure, using a tripod (sold separately).
 Sunrise & Sunset* ([SUNRISE & SUNSET])	Shoots the scenes under the glow of sunset/sunrise vividly.
 Fireworks* ([FIREWORKS])	Shoots fireworks with optimal exposure.



Setting values	Recording conditions
 Landscape* ([LANDSCAPE])	Shoots distant subjects clearly. This setting also prevents your camcorder from focusing on any glass or mesh in windows between the camcorder and the subject.
 Portrait ([PORTRAIT])	Brings out the subject, such as people or flowers, while creating a soft background.
 Spotlight ([SPOTLIGHT])	Prevents people's faces from appearing excessively white when subjects are lit by strong light.
 Beach ([BEACH])	Takes the vivid blue of the ocean or a lake.

\* Focuses on only distant subjects.

## Shooting in dimly lit locations (LOW LUX)

You can shoot bright video, even in low light conditions, such as outdoor locations with limited street lighting or dimly lit indoors, by automatically optimizing the gain and shutter speed.

### Note

This function is available only when FULL AUTO is turned on and [AUTO MODE SET] is set to "AUTO."

## 1 Press the FULL AUTO button to set auto mode on.

The FULL AUTO button lamp (green) turns on.

## 2 Assign [LOW LUX] to an ASSIGN button (p. 62).

## 3 Press the ASSIGN button.

-  is displayed.
- To cancel, press the ASSIGN button again.

## Shooting in dark conditions (NIGHTSHOT)

You can shoot scenes under very dark conditions.

### Note

This function is available only when FULL AUTO is turned on.

## 1 Press the FULL AUTO button to set auto mode on.

The FULL AUTO button lamp (green) turns on.

## 2 Assign [NIGHTSHOT] to an ASSIGN button (p. 62).

## 3 Press the ASSIGN button.

-  is displayed.
- To cancel, press the ASSIGN button again.

### Notes

- NIGHTSHOT uses infrared light. Make sure that your finger does not cover the NIGHTSHOT light emitter (p. 10) when shooting.
- Do not use NIGHTSHOT in bright conditions. Doing so may damage the camcorder.

### Customizing the picture quality (Picture Profile)

You can customize the picture quality by adjusting picture profile items such as [GAMMA] and [DETAIL]. You can make adjustments for the time of day, weather conditions, or just personal preference. Connect your camcorder to a TV or monitor, and adjust the picture quality while observing the picture on the TV or monitor screen.

Picture quality settings for different recording conditions have been stored in [PP1] through [PP6] as default settings.





#### Note

- [PP4] is set for the picture profile by default.





Picture profile number	Example setting
PP1	Example settings of a color tone with [STANDARD] gamma
PP2	Example settings of a color tone with [STILL] gamma
PP3	Example settings of natural color tone with [ITU709] gamma
PP4	Example settings of a color tone that is faithful to [ITU709]
PP5	Example settings of pictures recorded on cinema color negative film
PP6	Example settings of pictures screened with cinema color print film

### **1** Press the MENU button.

---

**2** Select  (CAMERA SET) → [PICTURE PROFILE] → the desired picture profile number using the /SET button, then press the button again.

---

**3** Press the /SET button, select [OK], then press the button again.





You can record with the settings of the selected picture profile.

---

#### Tip

















You can also select a picture profile by pressing an ASSIGN button assigned with [PICTURE PROFILE].





### To cancel picture profile recording

Select [OFF] in step **2** with the /SET button, then press the button.

### To change the picture profile

You can change the settings stored in [PP1] through [PP6].

- ① In step **3**, press the /SET button, select [SETTING], then press the button again.
- ② Press the /SET button, select the item that you want to adjust, then press the button again.
- ③ Press the /SET button, adjust the picture quality, then press the button again.
- ④ Repeat steps ② and ③ to adjust other items.
- ⑤ Press the /SET button, select [ RETURN], then press the button again.

- ⑥ Press the ////SET button, select [OK], then press the button again. The picture profile indicator is displayed.

## Useful functions (Continued)

### BLACK LEVEL

To set the black level.

Item	Description and settings
	Sets the black level. -15 to +15

### GAMMA

To select a gamma curve.

Item	Description and settings
[STANDARD]	Standard gamma curve
[STILL]	Gamma curve to create the tone of a still image.
[CINEMATONE1]	Gamma curve 1 for producing tone of film camera images
[CINEMATONE2]	Gamma curve 2 for producing tone of film camera images
[ITU709]	Gamma curve that corresponds to ITU-709. Gain in low intensity area: 4.5

#### Note

- There is no still image shooting mode on the camcorder.

### BLACK GAMMA

To correct gamma in low intensity area.

Item	Description and settings
[RANGE]	Selects a correcting range. HIGH / MIDDLE / LOW
[LEVEL]	Sets the correcting level. -7 (maximum black compression) to +7 (maximum black stretch)

## KNEE

To set knee point and slope for video signal compression to prevent over-exposure by limiting signals in high intensity areas of the subject to the dynamic range of your camcorder.

When selecting [STANDARD] or [STILL] in [GAMMA], [KNEE] is set to off if [MODE] is set to [AUTO]. To use functions in [KNEE], set [MODE] to [MANUAL].

Item	Description and settings
[MODE]	Selects a mode either automatic or manual. [AUTO] : Sets the knee point and slope automatically. [MANUAL] : Sets the knee point and slope manually.
[AUTO SET]	Sets the maximum point and sensitivity in [AUTO] mode. [MAX POINT] : Sets the maximum point. 90% to 100% [SENSITIVITY] : Sets the sensitivity. HIGH / MIDDLE / LOW
[MANUAL SET]	Sets the knee point and slope in [MANUAL] mode. [POINT] : Sets the knee point. 75% to 105% [SLOPE] : Sets the knee slope. -5 (gentle) to +5 (steep) [KNEE] is set to off when you set to +5.

## COLOR MODE

To set type and level of colors.

Item	Description and settings
[STANDARD]	Suitable colors when [GAMMA] is set to [STANDARD].
[STILL]	Suitable colors when [GAMMA] is set to [STILL].
[CINEMATONE1]	Film camera image-like colors good with [GAMMA] set to [CINEMATONE1].
[CINEMATONE2]	Film camera image-like colors good with [GAMMA] set to [CINEMATONE2].
[PRO]	Natural colors when [GAMMA] is set to [ITU709].
[ITU709 MATRIX]	Colors that are faithful to the ITU-709 standard (when used with ITU-709 gamma).
[B/W]	Sets the saturation to 0 and records in black and white.

## Useful functions (Continued)

### SATURATION

To set the color level.

Item	Description and settings
	-32 (light) to +32 (dark)

### COLOR PHASE

To set the color phase.

Item	Description and settings
	-7 (greenish) to +7 (reddish)

### COLOR DEPTH

To set the color depth for each color phase.

This function is more effective for chromatic colors and less effective for achromatic colors. The color looks deeper as you increase the setting value to more positive side, and lighter as you decrease the value to more negative side.

Item	Description and settings
[R]	-7 (light red) to +7 (deep red)
[G]	-7 (light green) to +7 (deep green)
[B]	-7 (light blue) to +7 (deep blue)
[C]	-7 (light cyan) to +7 (deep cyan)
[M]	-7 (light magenta) to +7 (deep magenta)
[Y]	-7 (light yellow) to +7 (deep yellow)

### COLOR CORRECTION

To set the color correction.

Item	Description and settings
TYPE	Selects color correction type. [OFF]: Not correct colors. [COLOR REVISION]: Corrects colors stored in memory. Colors not stored in memory (displayed in black and white when [COLOR EXTRACT] is set) will not be corrected. [COLOR EXTRACT]: Displays areas in colors that are stored in the memory. The other areas are displayed in black and white. You can use this function to add effects to your movies or to confirm the colors to be stored in the memory.
MEMORY SELECTION	Selects a memory to enable. [1]: Enable memory 1 only. [2]: Enable memory 2 only. [1&2]: Enable both memory 1 and 2.

Item	Description and settings
MEMORY1 COLOR	Sets the color stored in Memory 1. [PHASE]: Sets color phase. 0 (purple) to 8 (red) to 16 (yellow) to 24 (green) to 31 (blue) [PHASE RANGE]: Sets color phase range. 0 (no color selection), 1 (narrow: to select only a single color) to 31 (wide: to select multiple colors in similar color phase) [SATURATION]: Sets saturation. 0 (to select from light colors to dark colors) to 31 (to select dark color) [ONE PUSH SET]: Automatically sets [PHASE] for a subject at the center of the marker. [SATURATION] is set to 0.
MEMORY1 REVISION	Corrects the color in Memory 1. [PHASE]: Corrects the phase of the color in Memory 1. -15 to +15 (0 for no correction.) [SATURATION]: Corrects the saturation of the color in Memory 1. -15 to +15 (0 for no correction.)
MEMORY2 COLOR	Sets colors stored in Memory 2. See [MEMORY1 COLOR] for description and settings.
MEMORY2 REVISION	Corrects colors in Memory 2. See [MEMORY1 REVISION] for description and settings.

### Tips

- Setting both memories to the same setting doubles the color correction effect.
- The settings of [COLOR CORRECTION] will be retained even if the power is turned off. However, if you want to correct colors that may change according to time of the day, weather, location, etc., it is recommended that you set [COLOR CORRECTION] again prior to recording.
- If you change the white balance value or the settings of [WB SHIFT], [SATURATION] or [COLOR PHASE] of the picture profile, the settings of [PHASE RANGE] and [PHASE] of the selected memory will change. When you change the white balance value or the settings of the above picture profile items after you have set [PHASE RANGE] and [PHASE], check the settings of [COLOR CORRECTION] prior to recording.
- During the automatic white balance adjustment, the white balance value automatically varies according to the lighting conditions of your recording environment. Manual white balance adjustment is recommended when you use [COLOR CORRECTION].

## Useful functions (Continued)

### WB SHIFT

To set items for the white balance shift.

Items you can adjust differ depending on the filter type.

Item	Description and settings
[FILTER TYPE]	Selects a color filter type for the white balance shift. [LB-CC] : Film type (color conversion and correction) [R-B] : Video type (correction of R and B levels)
[LB[COLOR TEMP]]	Sets a color temperature offset value. -9 (bluish) to +9 (reddish)
[CC[MG/GR]]	Sets a color correct offset value. -9 (greenish) to +9 (magentish)
[R GAIN]	Sets an R level. -9 (low R level) to +9 (high R level)
[B GAIN]	Sets a B level. -9 (low B level) to +9 (high B level)

### DETAIL

To set items for the detail.

Item	Description and settings
[LEVEL]	Sets the detail level. -7 to +7
[MANUAL SET]	[ON/OFF] : Turns on and off the manual detail adjustment. Set to [ON] to enable the manual detail adjustment (automatic optimization will not be performed).
	[V/H BALANCE] : Sets the vertical (V) and horizontal (H) balance of DETAIL. -2 (off to the vertical (V) side) to +2 (off to the horizontal (H) side)
	[B/W BALANCE] : Selects the balance of the lower DETAIL (B) and the upper DETAIL (W). TYPE1 (off to the lower DETAIL (B) side) to TYPE5 (off to the upper DETAIL (W) side)
	[LIMIT] : Sets the limit level of DETAIL. 0 (Low limit level: likely to be limited) to 7 (High limit level: not likely to be limited)
	[CRISPENING] : Sets the crispening level. 0 (shallow crispening level) to 7 (deep crispening level)
	[HI-LIGHT DETAIL] : Sets the DETAIL level in the high intensity areas. 0 to 4



## COPY

To copy the settings of the picture profile to another picture profile number.

## RESET

To reset the picture profile to the default setting.

### To copy the picture profile setting to another picture profile number

- 1 Press the MENU button.
- 2 Select (CAMERA SET) → [PICTURE PROFILE] → the desired picture profile number using the ////SET button, then press the button again.
- 3 Press the ////SET button, then select [SETTING] → [COPY].
- 4 Press the ////SET button, select the picture profile number of the destination, then press the button again.
- 5 Press the ////SET button, then select [YES] → [ RETURN ] → [OK].

### To reset the picture profile settings

You can reset the picture profile settings by each picture profile number. You cannot reset all picture profile settings at once.

- 1 Press the MENU button.
- 2 Select (CAMERA SET) → [PICTURE PROFILE] → the desired picture profile number using the ////SET button, then press the button again.
- 3 Press the ////SET button, then select [SETTING] → [RESET] → [YES] → [ RETURN ] → [OK].

## Setting time data

The camcorder records movies accompanied by time data, such as time code and user bit.

## Setting the time code

- 1 Press the MENU button, press the ////SET button and select (TC/UB SET) → [TC PRESET], then press the button again.
- 2 Press the ////SET button, select [PRESET], then press the button again.
- 3 Press the ////SET button, select the first two digits, then press the button again. You can set the time code within the following range.  
When [60i] is selected:  
00:00:00:00 to 23:59:59:29  
• When setting 24p, you can set the last 2 time code digits of the frames in multiples of 4, between 0 and 23.  
When [50i] is selected:  
00:00:00:00 to 23:59:59:24
- 4 Set other digits by repeating step ③.
- 5 Press the ////SET button, select [OK], then press the button again.

### To reset the time code

Select [RESET] in step ② of “Setting the time code” to reset the time code (00:00:00:00).

### To reset the time code using the Wireless Remote Commander

You can reset the time code (00:00:00:00) also by pressing the TC RESET button on the Wireless Remote Commander.

## Setting the user bits

- 1 Press the MENU button, press the ////SET button and select (TC/UB SET) → [UB PRESET], then press the button again.
- 2 Press the ////SET button, select [PRESET], then press the button again.

## Useful functions (Continued)

- ③ Press the  $\blacktriangle/\blacktriangledown/\blacktriangleleft/\blacktriangleright$ /SET button, select the first two digits, then press the button again.
- ④ Set other digits by repeating step ③.
- ⑤ Press the  $\blacktriangle/\blacktriangledown/\blacktriangleleft/\blacktriangleright$ /SET button, select [OK], then press the button again.

### To reset the user bits

Select [RESET] in step ② of “Setting the user bits” to reset the user bits (00 00 00 00).

### Slow-motion recording at high frame rate (HFR)

You can use slow-motion recording at high frame rate (HFR) in XAVC HD.

#### Playback speed

The playback speeds based on the recording format are as follows.

#### When [60i] is selected

REC MEDIA	1080/24p	1080/30p	1080/60p
120	20% slow	25% slow	50% slow

#### When [50i] is selected

REC MEDIA	1080/25p	1080/50p
100	25% slow	50% slow

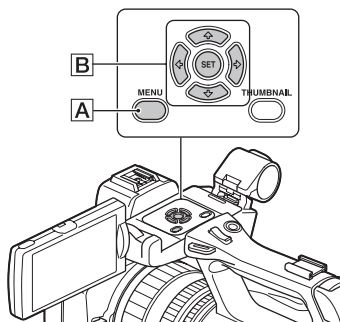

### Preparation

- ① Press the MENU button **A**.
- ② Select  $\blacktriangle/\blacktriangledown/\blacktriangleleft/\blacktriangleright$  (CAMERA SET)  $\rightarrow$  [S&Q MOTION]  $\rightarrow$  [HIGH FRAME RATE]  $\rightarrow$  ON with the  $\blacktriangle/\blacktriangledown/\blacktriangleleft/\blacktriangleright$ /SET button **B**.
- ③ Select [REC FORMAT].
- ④ Select a recording format.  
(Default setting in bold)

60i	50i
1080/60p 50Mbps	1080/50p 50Mbps
1080/30p 25Mbps	<b>1080/25p 25Mbps</b>
<b>1080/24p 25Mbps</b>	—

The frame rate is fixed to the following value.

When [60i] is selected: 120

When [50i] is selected: 100

For details about shooting, see “Recording with the Slow & Quick Motion function” (p. 58).

### Recording with the Slow & Quick Motion function

By recording with a frame rate that is different from the playback frame rate, you can record images to be played back as

slow motion or quick motion images. The images recorded with the Slow & Quick Motion function will appear smoother than slow or fast-forward playback of images recorded at normal speed.

## Playback speed

The playback speeds based on the recording format and frame rate setting are as follows.

## XAVC HD/AVCHD

### When [60i] is selected

REC MEDIA	REC FORMAT		
	1080/24p	1080/30p	1080/60p
60	40% slow	50% slow	100% (standard)
30	80% slow	100% (standard)	200% quick
15	160% quick	200% quick	400% quick
8	300% quick	375% quick	750% quick
4	600% quick	750% quick	1500% quick
2	1200% quick	1500% quick	3000% quick
1	2400% quick	3000% quick	6000% quick

### When [50i] is selected

REC MEDIA	REC FORMAT	
	1080/25p	1080/50p
50	50% slow	100% (standard)
25	100% (standard)	200% quick
12	208% quick	417% quick
6	417% quick	833% quick
3	833% quick	1667% quick
2	1250% quick	2500% quick
1	2500% quick	5000% quick

## MPEG HD 422/MPEG HD 420

### When [60i] is selected

REC MEDIA	REC FORMAT	
	1080/24p	1080/30p
30	80% slow	100% (standard)
15	160% quick	200% quick
8	300% quick	375% quick
4	600% quick	750% quick
2	1200% quick	1500% quick
1	2400% quick	3000% quick

### When [50i] is selected

REC MEDIA	REC FORMAT
	1080/25p
25	100% (standard)
12	208% quick
6	417% quick
3	833% quick
2	1250% quick
1	2500% quick

## Notes

- You cannot use the Slow & Quick Motion function with XAVC QFHD.
- For details about the recording media that can be used to record with Slow & Quick Motion, see page 27.
- When recording with the Quick Motion recording function, your camcorder may continue recording for some time (approximately 30 seconds at most) after you press the button to stop recording. Do not operate your camcorder while the [REC] indicator is flashing on the screen, and wait till it turns to [STBY].
- After you press the button to stop recording, your camcorder continues recording till it completes writing of the minimum unit of data (0.5 seconds of replay time).

## Useful functions (Continued)

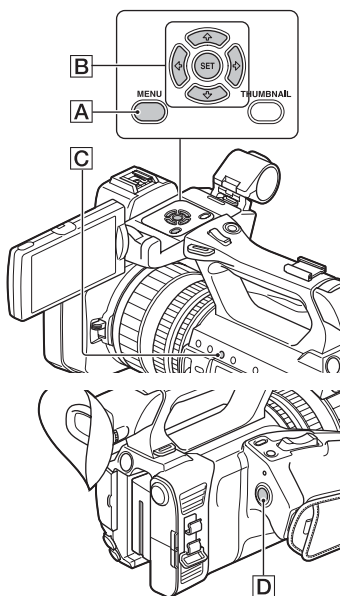

### Preparation

You must set the recording format and frame rate.

- ① Press the MENU button **A**.
- ② Select (CAMERA SET) → [S&Q MOTION] → [REC FORMAT] with the /SET button **B**.
- ③ Select a recording format.

### XAVC HD

(Default setting in bold)

60i	50i
1080/60p 50Mbps	1080/50p 50Mbps
1080/60p 35Mbps	1080/50p 35Mbps
1080/30p 50Mbps	<b>1080/25p 50Mbps</b>
1080/30p 35Mbps	1080/25p 35Mbps
<b>1080/24p 50Mbps</b>	–

60i	50i
1080/24p 35Mbps	–

### MPEG HD 422

(Default setting in bold)

60i	50i
1080/30p 50Mbps	<b>1080/25p 50Mbps</b>
<b>1080/24p 50Mbps</b>	–

### MPEG HD 420

(Default setting in bold)

60i	50i
1080/30p HQ	<b>1080/25p HQ</b>
<b>1080/24p HQ</b>	–

### AVCHD

(Default setting in bold)

60i	50i
1080/60p PS	1080/50p PS
1080/30p FX	<b>1080/25p FX</b>
1080/30p FH	1080/25p FH
<b>1080/24p FX</b>	–
1080/24p FH	–

- ④ Select [REC MEDIA] with the /SET button **B**, and set the desired frame rate.

(Default setting in bold)

60i	50i
<b>60fps*</b>	<b>50fps*</b>
30fps	25fps
15fps	12fps
8fps	6fps
4fps	3fps
2fps	2fps
1fps	1fps

\* 60fps and 50fps cannot be selected in MPEG HD 422/MPEG HD 420.

- ⑤ Select [ RETURN].

## Recording in Slow & Quick Motion mode

- ① Select (CAMERA SET) → [S&Q MOTION] → [EXECUTE] with the /SET button **[B]** or press the ASSIGN3/S&Q button **[C]**.
- ② Press the START/STOP button **[D]**. Slow & Quick Motion recording starts.

## To stop Slow & Quick Motion recording

Press the START/STOP button **[D]**.

## To change the frame rate setting

Hold the ASSIGN button down for about 1 second, then change the value with the /SET button **[B]**.

Holding the ASSIGN button down again for about 1 second restores the previous setting.

## To cancel Slow & Quick Motion recording

Press the ASSIGN button or the MENU button **[A]** during standby.

### Notes

- When you are recording with a slow frame rate, the camcorder may continue recording for a few more seconds after you press the START/STOP button to stop recording.
- You cannot change the frame rate during Slow & Quick Motion recording. To change the frame rate, stop current Slow & Quick Motion recording.
- The time code is recorded in [REC RUN] mode during Slow & Quick Motion recording (p. 110).
- Slow & Quick Motion mode is automatically canceled when the camcorder is turned off, but the frame rate setting is retained.
- You cannot record sound during Slow & Quick Motion recording.
- You cannot use the Slow & Quick Motion function for the simultaneous recording.
- You cannot use the Slow & Quick Motion function when FULL AUTO is turned on.

## Reviewing the most recently recorded scene (Last Scene Review)

You can review the most recently recorded scene on the LCD screen.

[LAST SCENE REVIEW] is assigned to the ASSIGN4/LAST SCENE button (p. 62).

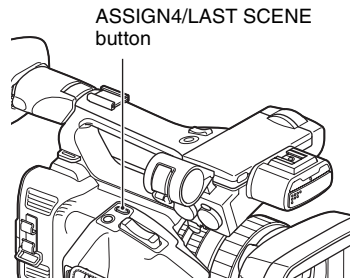

## After you stop recording, press the ASSIGN4/LAST SCENE button.

The camcorder plays from the start to the end of the most recently recorded scene, then returns to standby mode.

## To stop reviewing the last scene

Press the ASSIGN4/LAST SCENE button during playback. The camcorder returns to standby mode.

### Note

- If you edit the movie or remove the recording media after you stop recording, the Last Scene Review function may not work correctly.

# Assigning functions to the ASSIGN buttons

Some functions can be assigned to the ASSIGN buttons.

You can assign a single function to each of the ASSIGN1 to 6 buttons.

See “Menu items” (p. 99) on the function of each item.

## Default function of each ASSIGN button

- ASSIGN1: WB SET (p. 44)
- ASSIGN2: STATUS CHECK (p. 69)
- ASSIGN3: S&Q MOTION (p. 58)
- ASSIGN4: LAST SCENE REVIEW (p. 61)
- ASSIGN5: FOCUS MAGNIFIER (p. 34)
- ASSIGN6: VF/LCD PANEL (p. 109)

## Functions you can assign to the ASSIGN buttons

- – (no function)
- LOW LUX (p. 49)
- FOCUS MAGNIFIER (p. 34)
- LAST SCENE REVIEW (p. 61)
- WHT BAL (p. 43)
- WB PRESET (p. 99)
- WB SET (p. 44)
- AE SHIFT (p. 99)
- D. EXTENDER (p. 99)
- STEADYSHOT (p. 100)
- S&Q MOTION (p. 58)
- AUTO MODE SET (p. 48)
- SCENE SELECTION SET (p. 48)
- NIGHTSHOT (p. 49)
- IRIS PUSH AUTO (p. 41)
- FACE DETECTION (p. 35)
- COLOR BAR (p. 102)
- MENU (p. 98)
- PICTURE PROFILE (p. 50)
- VOLUME (p. 104)
- HISTOGRAM (p. 107)
- ZEBRA (p. 107)
- PEAKING (p. 107)
- MARKER (p. 108)

- CAMERA DATA DISPLAY (p. 108)
- AUDIO LEVEL DISPLAY (p. 109)
- DATA CODE (p. 109)
- VF/LCD PANEL (p. 109)
- TC/UB DISPLAY (p. 110)
- SMARTPHONE CONNECT (p. 78)
- STREAMING (p. 87)
- STREAM OPERATION (p. 88)
- FTP TRANSFER (p. 89)
- STATUS CHECK (p. 69)
- REC LAMP (p. 113)
- THUMBNAIL (p. 64)

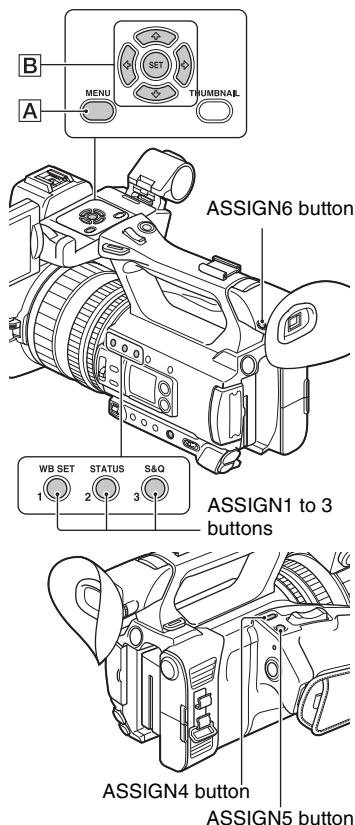

- 
- 1** Press the MENU button **[A]**.
- 
- 2** Select **[OTHERS]** → **[ASSIGN BUTTON]** with the **↑/↓/←/→/SET** button **[B]**.

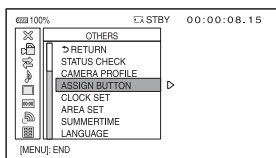

- 
- 3** Press the **↑/↓/←/→/SET** button **[B]**, select the ASSIGN button that you want to set, then press the button again.
- 
- 4** Press the **↑/↓/←/→/SET** button **[B]**, select the function that you want to assign, then press the button again.
- 
- 5** Press the **↑/↓/←/→/SET** button **[B]**, select **[OK]**, then press the button again.
-

# Playback

THUMBNAIL button

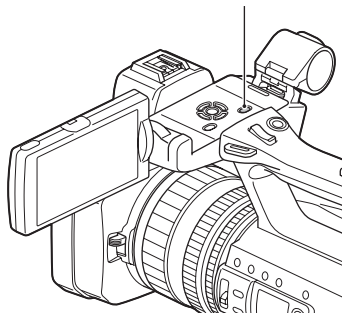

## Playback

**1** Open the LCD panel.

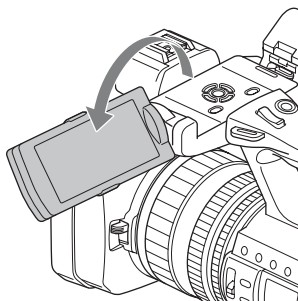



## 2 Press the THUMBNAIL button.

The THUMBNAIL screen appears after a few seconds.

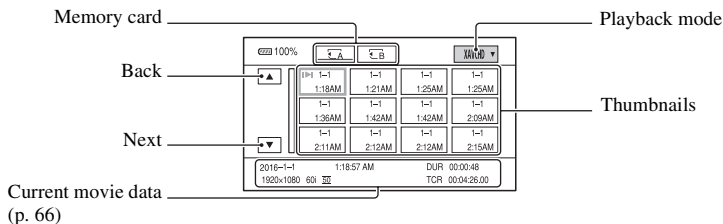

- You can turn on or off the date and time display on the thumbnails by pressing the DISPLAY button.
- Icons may also be displayed on thumbnails.

Proxy recording (p. 39) icon

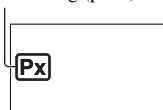

Protected (p. 94) icon

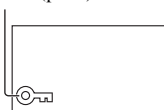

## 3 Play a movie.

- ① Select the memory card you want to play using the  $\blacktriangle/\blacktriangledown/\blacktriangleleft/\blacktriangleright$ /SET button, then press the SET button

$\overline{A}$  : Memory card A

$\overline{B}$  : Memory card B

- ② Select the playback mode using the  $\blacktriangle/\blacktriangledown/\blacktriangleleft/\blacktriangleright$ /SET buttons.

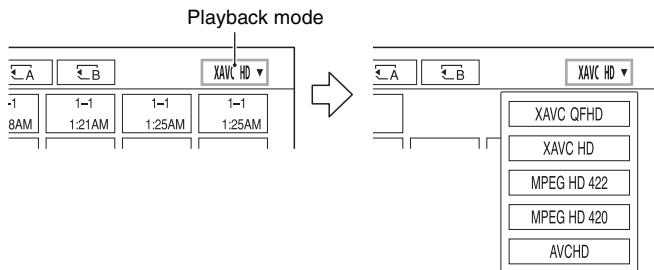

## Playback (Continued)

- ③ Select the thumbnail you want to play using the  $\blacktriangle/\blacktriangledown/\blacktriangleleft/\blacktriangleright$  buttons, and press the SET button. Selecting the thumbnail will show information about the movie in the lower part of the LCD screen.

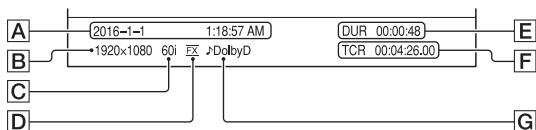

**A** Date and time of recording started

**B** Resolution

**C** Frame rate

**D** Recording mode

**E** Recording time

**F** Time code of recording started

Time code will not be displayed correctly when you play back a memory card with no time code, or a memory card with time code that your camcorder does not support.

**G** DOLBY DIGITAL recording

Displayed when audio is recorded in Dolby Digital format.

- ▶| appears with the movie that has been most recently played back or recorded. Selecting it will continue playback from the previous time.

Playback starts.

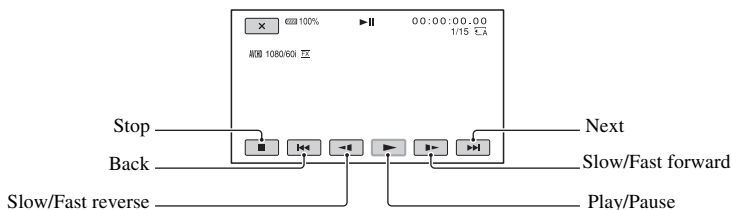

### Tips

- When playback from the selected movie reaches the last movie, the screen returns to the THUMBNAIL screen.
- Select  $\blacktriangleleft/\blacktriangleright$  during pause to play back movies slowly.
- The playback speed increases based on the number of times that you select  $\text{⏮}/\text{⏭}$ .

### To adjust the volume

Press the MENU button and select  $\text{🎵}$  (AUDIO SET)  $\rightarrow$  [VOLUME] to adjust the volume.

## **To return to recording mode**

Press the THUMBNAIL button.

## **On playing back movies**

- Movies recorded using this camcorder may not be played back normally on devices other than this camcorder. Also, movies recorded on other devices may not play back properly on this camcorder.

# Changing/checking the settings in your camcorder

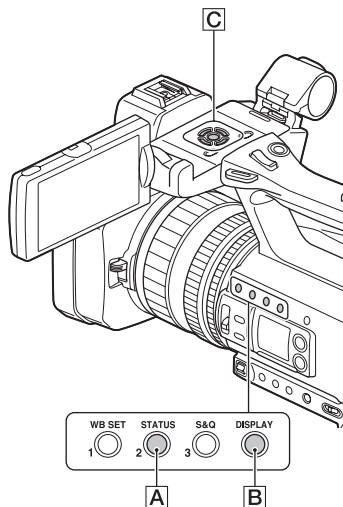

## Changing the screen display

You can display information such as time code, etc., on the image.

Press the **DISPLAY** button **[B]**.

The screen indicators turn on (displayed) ↔ off (not displayed) each time you press the button. In recording mode, the screen changes in the order, detailed display → simple display → no display with each press of the button.

### Tip

- You can display the screen indicators during playback on a TV by setting [DISPLAY OUTPUT] to [ALL OUTPUT] (p. 109).

## Displaying recording data (Data Code)

You can display information, including date, time and camera data automatically stored during recording on the screen during playback.

Select **[DISPLAY SET]** → **DATA CODE** and choose the data that you want to display, or press the **ASSIGN** button to which the **DATA CODE** function is assigned, during playback or pause.

The screen changes in the order, date and time display → camera data display → no display with each press of the button.

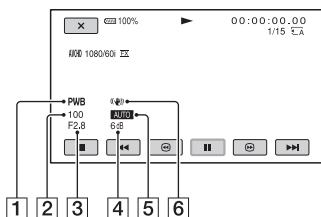

- 1** White balance  
**PWB** appears during the playback of movies recorded with [MANU WB TEMP].
- 2** Shutter speed
- 3** Iris
- 4** Gain
- 5** Exposure  
**AUTO** appears during playback of the movie recorded with the iris, gain, and shutter speed automatically adjusted.  
**MANUAL** appears during playback of the movie recorded with the iris, gain, and shutter speed manually adjusted.

## 6 Camera shake correction (Steady Shot)

### Notes

- Data code is not recorded in XAVC QFHD, XAVC HD, and MPEG HD modes.
- When you play back the memory card on other devices, the camera data may be displayed incorrectly. Confirm the correct camera data on your camcorder.

## Checking the settings in your camcorder (Status Check)

You can check the settings of the following items.

- Audio setup (p. 104)
  - Output signal setup (p. 103)
  - Functions assigned to the ASSIGN buttons (p. 62)
  - Camera setup (p. 99)
  - Record button setup (p. 32)
  - Memory card information
  - Battery information
- Record button setup  
You can check the record button setting.

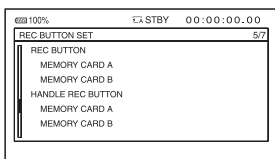

- Memory card information  
You can check the estimated used and free spaces.

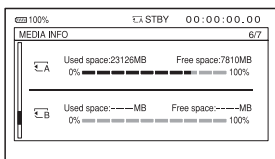

### Battery Info

You can check the remaining capacity of the attached battery.

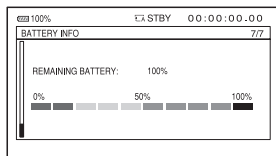

[STATUS CHECK] is assigned to the ASSIGN2/STATUS button **A** (p. 62).

## 1 Press the ASSIGN2/STATUS button **A**.

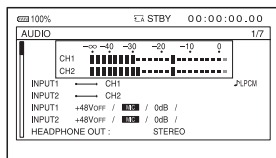

## 2 Press the **↑/↓/←/→/SET** button **C** to display the items.

Switches in the order AUDIO → OUTPUT → ASSIGN → CAMERA → REC BUTTON SET → MEDIA INFO → BATTERY INFO.

Setup items are displayed according to the settings of the camcorder when it is turned on.

## To hide the display

Press the ASSIGN2/STATUS button **A**.

# Connecting to a monitor or a TV

Playback image quality depends on the type of monitor or TV, or the jacks used to make the connection.

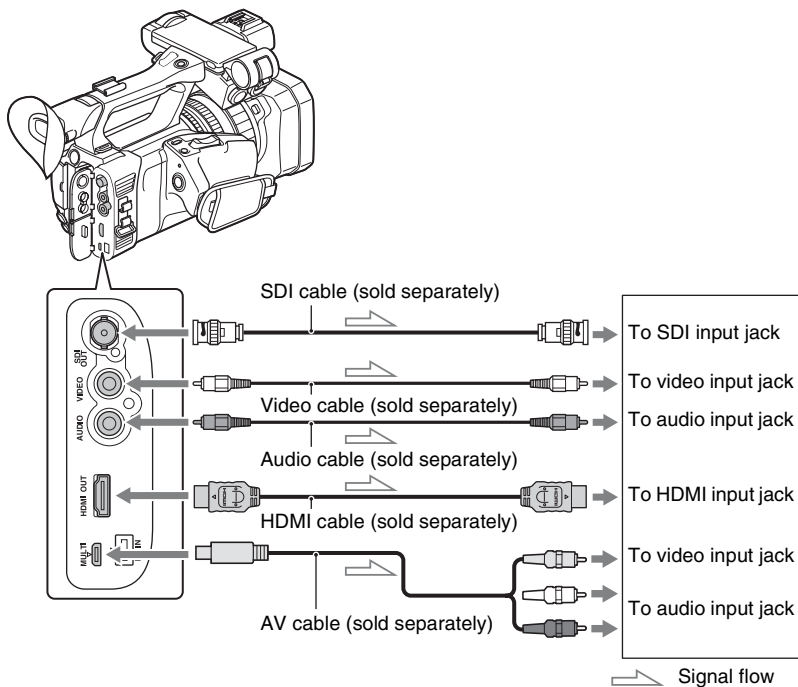

## Notes

- Video signals cannot be output from the output jacks above simultaneously.
- The output resolution of VIDEO OUT is 480i for 60i models, and 576i for 50i models.

## Tip

- VIDEO OUT and AUDIO OUT are integrated into the Multi/Micro USB jack. To connect to the video input or audio input jack of a monitor or TV, use an AV cable (sold separately). The VMC-15MR2 is recommended.

## Selecting jacks for external output

**1** Press the MENU button.

**2** Select  $\rightleftarrows$  (REC/OUT SET) → [VIDEO OUT] → [OUTPUT SELECT] → [OUTPUT SELECT] → desired output destination with the  $\blacktriangle$ / $\blacktriangledown$ / $\blacktriangleleft$ / $\blacktriangleright$ /SET button.

### Notes

- It is recommended that you use an authorized cable with HDMI logo or a Sony HDMI cable.
- Images are not output from the HDMI OUT jack of your camcorder, if copyright protection signals are recorded in the movies.
- Images and sounds may not be reproduced correctly on some monitors or TVs.
- Do not connect the output jacks of the camcorder with the output jacks of the monitor or TV. A malfunction may be caused.
- If you display the edit screen while outputting signals to a monitor or TV, the menu may not be displayed correctly.
- This camcorder is not compatible with “BRAVIA” sync.

## Connecting to a monitor or a TV (Continued)

### Output signal formats

The signal format of the outputs from the SDI OUT jack, HDMI OUT jack, and multi/micro USB jack is shown below.

#### SDI OUT/HDMI OUT output format (when [60i] is selected)

##### XAVC QFHD

--: Independent of set value

Menu item				
Recording format	SDI/HDMI	24p/30p	SDI OUT output signal format	HDMI OUT output signal format
REC/OUT SET> REC SET> REC FORMAT	REC/OUT SET> VIDEO OUT> SDI/HDMI	REC/OUT SET> VIDEO OUT> 24p/30p		
2160/24p	2160p/1080p/480i	24p/30p <sup>**</sup>	1080/24p	2160/24p
		24PsF/30PsF <sup>**</sup>	1080/24psf	
		60p(Pull Down) <sup>**</sup>	1080/60p	
	2160p/720p/480i	–	720/60p	
	2160p/1080i/480i		1080/60i	
	1080p/480i	24p/30p	1080/24p	During recording: 1080/24p During playback: 1080/60p
		24PsF/30PsF	1080/24psf	
		60p(Pull Down)	1080/60p	
	720p/480i	–	720/60p	720/60p
	1080i/480i		1080/60i	1080/60i
480p		No output	480/60p	
480i		480/60i	480/60i	



Menu item				
Recording format	SDI/HDMI	24p/30p	SDI OUT output signal format	HDMI OUT output signal format
REC/OUT SET> REC SET> REC FORMAT	REC/OUT SET> VIDEO OUT> SDI/HDMI	REC/OUT SET> VIDEO OUT> 24p/30p		
2160/30p	2160p/1080p/480i	24p/30p <sup>*1</sup>	1080/30p	2160/30p
		24PsF/30PsF <sup>*1</sup>	1080/30psf	
		60P(Pull Down) <sup>*1</sup>	1080/60p	
	2160p/720p/480i	–	720/60p	
	2160p/1080i/480i		1080/60i	
	1080p/480i	24p/30p <sup>*1</sup>	1080/30p	1080/60p
		24PsF/30PsF <sup>*1</sup>	1080/30psf	
		60p(Pull Down) <sup>*1</sup>	1080/60p	
	720p/480i	–	720/60p	720/60p
	1080i/480i		1080/60i	1080/60i
	480p		No output	480/60p
	480i		480/60i	480/60i

\*1 HDMI OUT is independent of set value.

## Connecting to a monitor or a TV (Continued)

### XAVC HD/MPEG HD 422/MPEG HD 420/AVCHD

--: Independent of set value

Menu item				
Recording format	SDI/HDMI	24p/30p	SDI OUT output signal format	HDMI OUT output signal format
REC/OUT SET> REC SET> REC FORMAT	REC/OUT SET> VIDEO OUT> SDI/HDMI	REC/OUT SET> VIDEO OUT> 24p/30p		
1080/24p	2160p/1080p/480i	24p/30p	1080/24p	During recording: 1080/24p During playback: 1080/60p
		24PsF/30PsF	1080/24psf	
		60p(Pull Down)	1080/60p	
	2160p/720p/480i	–	720/60p	720/60p
	2160p/1080i/480i		1080/60i	1080/60i
	1080p/480i	24p/30p	1080/24p	During recording: 1080/24p During playback: 1080/60p
		24PsF/30PsF	1080/24psf	
		60p(Pull Down)	1080/60p	
	720p/480i	–	720/60p	720/60p
	1080i/480i		1080/60i	1080/60i
	480p		No output	480/60p
	480i		480/60i	480/60i
	1080/30p	2160p/1080p/480i	24p/30p <sup>**</sup>	1080/30p
24PsF/30PsF <sup>**</sup>			1080/30psf	
60p(Pull Down) <sup>**</sup>			1080/60p	
2160p/720p/480i		–	720/60p	720/60p
2160p/1080i/480i			1080/60i	1080/60i
1080p/480i		24p/30p <sup>**</sup>	1080/30p	1080/60p
		24PsF/30PsF <sup>**</sup>	1080/30psf	
		60p(Pull Down) <sup>**</sup>	1080/60p	
720p/480i		–	720/60p	720/60p
1080i/480i			1080/60i	1080/60i
480p			No output	480/60p
480i			480/60i	480/60i

Menu item				
Recording format	SDI/HDMI	24p/30p	SDI OUT output signal format	HDMI OUT output signal format
REC/OUT SET> REC SET> REC FORMAT	REC/OUT SET> VIDEO OUT> SDI/HDMI	REC/OUT SET> VIDEO OUT> 24p/30p		
1080/60p	2160p/1080p/480i	–	1080/60p	1080/60p
720/60p	2160p/720p/480i		720/60p	720/60p
1080/60i	2160p/1080i/480i		1080/60i	1080/60i
1080/60i (1440)	1080p/480i		1080/60p	1080/60p
	720p/480i		720/60p	720/60p
	1080i/480i		1080/60i	1080/60i
	480p		No output	480/60p
	480i		480/60i	480/60i

\*1 HDMI OUT is independent of set value.

### Multi/micro USB jack output format (when [60i] is selected)

Output is always 480/60i.

## Connecting to a monitor or a TV (Continued)

### SDI OUT/HDMI OUT output format (when [50i] is selected)

#### XAVC QFHD

--: Independent of set value

Menu item			SDI OUT output signal format	HDMI OUT output signal format
Recording format	SDI/HDMI	50p		
REC/OUT SET> REC SET> REC FORMAT	REC/OUT SET> VIDEO OUT> SDI/HDMI	REC/OUT SET> VIDEO OUT> 50p		
2160/25p	2160p/1080p/576i	25p <sup>*1</sup>	1080/25p	2160/25p
		25PsF <sup>*1</sup>	1080/25psf	
		50p(Pull Down) <sup>*1</sup>	1080/50p	
	2160p/720p/576i	–	720/50p	
	2160p/1080i/576i		1080/50i	
	1080p/576i	25p <sup>*1</sup>	1080/25p	1080/50p
		25PsF <sup>*1</sup>	1080/25psf	
		50p(Pull Down) <sup>*1</sup>	1080/50p	
	720p/576i	–	720/50p	720/50p
	1080i/576i		1080/50i	1080/50i
	576p		No output	576/50p
	576i		576/50i	576/50i

\*1 HDMI OUT is independent of set value.

## XAVC HD/MPEG HD 422/MPEG HD 420/AVCHD

--: Independent of set value

Menu item					
Recording format	SDI/HDMI	50p	SDI OUT output signal format	HDMI OUT output signal format	
REC/OUT SET> REC SET> REC FORMAT	REC/OUT SET> VIDEO OUT> SDI/HDMI	REC/OUT SET> VIDEO OUT> 50p			
1080/25p	2160p/1080p/576i	25p*1	1080/25p	1080/50p	
		25PsF*1	1080/25psf		
		50p(Pull Down)*1	1080/50p		
	2160p/720p/576i	–	720/50p	720/50p	
	2160p/1080i/576i		1080/50i	1080/50i	
	1080p/576i	25p*1	1080/25p	1080/50p	
		25PsF*1	1080/25psf		
		50p(Pull Down)*1	1080/50p		
	720p/576i	–	720/50p	720/50p	
	1080i/576i		1080/50i	1080/50i	
	576p		No output	576/50p	
	576i		576/50i	576/50i	
	1080/50p	2160p/1080p/576i	–	1080/50p	1080/50p
	720/50p	2160p/720p/576i		720/50p	720/50p
1080/50i	2160p/1080i/576i		1080/50i	1080/50i	
1080/50i (1440)	1080p/576i		1080/50p	1080/50p	
	720p/576i		720/50p	720/50p	
	1080i/576i		1080/50i	1080/50i	
	576p		No output	576/50p	
	576i		576/50i	576/50i	

\*1 HDMI OUT is independent of set value.

### Multi/micro USB jack output format (when [50i] is selected)

Output is always 576/50i.

### Output in Slow & Quick Motion mode

In Slow & Quick Motion mode (including High Frame Rate), the output is 60p or 60i (when [60i] is selected), or 50p or 50i (when [50i] is selected).

For MPEG HD 422/420, the output for the 30p (25p)/30PsF (25PsF) setting is 30p (25p)/30PsF (25PsF).

# Using with a Smartphone

The Wi-Fi function of the camcorder enables you to operate the camcorder remotely by a smartphone.



## Downloading “Content Browser Mobile”

To use a smartphone as a remote control for the camcorder, you need to install the dedicated “Content Browser Mobile” application on your smartphone. If it is already installed on your smartphone, update it to the latest version.

### Android OS

Search for “Content Browser Mobile” in Google Play, then install it.



- You need Android 4.1 or later when you use the NFC One-touch.
- Google Play may not be supported depending on the country or region. In this case, search for “Content Browser Mobile” on the Internet, then install it.

### iOS

Search for “Content Browser Mobile” in the App Store, then install it.



You need iOS 7.0 or later.

- You cannot use NFC One-touch when you use iOS.

### Notes

- You need an NFC-compatible smartphone or tablet computer in order to use the NFC One-touch function of the camcorder.
- Proper operation of the Wi-Fi function detailed in this manual is not guaranteed for all smartphones or tablet computers.
- Operations and screen displays of the application may be subject to change without notice by future upgrades.

## Using a smartphone as a remote controller

You can control some of the camcorder’s shooting functions remotely with a smartphone.

---

**1 Press the MENU button.**

---

**2 Select  (NETWORK SET) → [CTRL W/SMARTPHONE] with the /SET button.**

---

**3 Connect the smartphone to the camcorder, using the information that appears on the screen when the camcorder is ready to be connected.**

The connection method will depend on the type of smartphone.

Android device with NFC function:  
page 79

Android: page 80

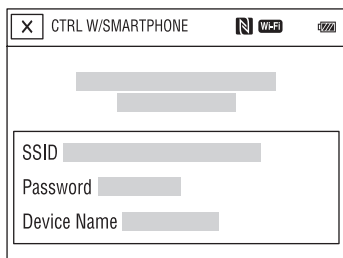

#### 4 Operate the camcorder using “Content Browser Mobile” installed on the smartphone.

For details on how to operate “Content Browser Mobile” after it starts, refer to the Help section in “Content Browser Mobile”.

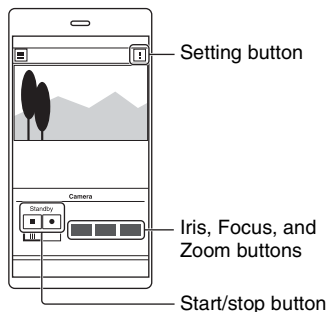

#### Notes

- Live view images may not be displayed smoothly, depending on the smartphone performance and/or transmission conditions.
- Movies cannot be recorded on a smartphone.
- For details about usage restrictions, see “Function limitations when recording” (p. 129).

#### Tip

- You can assign [SMARTPHONE CONNECT] to an ASSIGN button. You can start [CTRL W/SMARTPHONE] by pressing that ASSIGN button when the shooting screen is displayed (p. 62).

#### Functions that can be controlled using [CTRL W/SMARTPHONE]

- Recording start/stop
- Touch focus
  - Available when using manual focus.
- Zoom
- Iris adjustment

#### Note

- You cannot perform other operations during touch focus.

### Connecting the camcorder to an Android smartphone equipped with the NFC function using One-touch

- 1 Select [Settings] on the smartphone, then select [More...] and place a check mark next to [NFC].

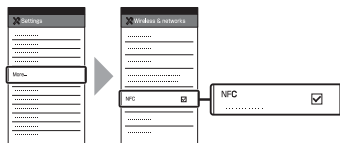

- 2 Set the camcorder to the shooting mode.

You can use the NFC function only when **N** (N mark) is displayed on the screen.

### 3 Touch the smartphone on the camcorder.

The smartphone connects to the camcorder, and “Content Browser Mobile” is activated.

[CTRL W/SMARTPHONE] starts on the camcorder.

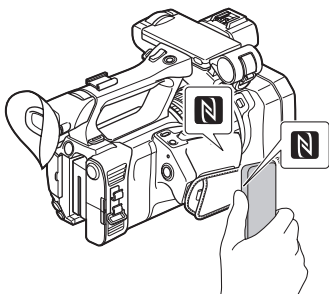

#### Tips

- Cancel the sleep mode and screen lock of the smartphone beforehand.
- Continue to touch (1 second-2 seconds) on the camcorder without moving, until “Content Browser Mobile” starts up.
- While [CTRL W/SMARTPHONE] is activated, only the START/STOP button and handle record button are available on the camcorder.
- The smartphone cannot be connected to the camcorder when [AIRPLANE MODE] is set to [ON]. Set [AIRPLANE MODE] to [OFF] (p. 111).

## Connecting without using the NFC function (Android)

- 1 Select [Settings] on your smartphone, then select [Wi-Fi] and the SSID (displayed on the camcorder).

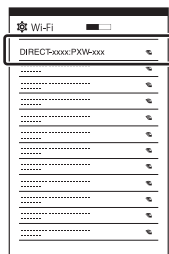

- 2 Input the password displayed on the camcorder (first time only).

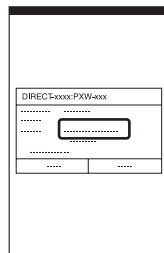



### 3 Confirm connection to the SSID displayed on the camcorder.

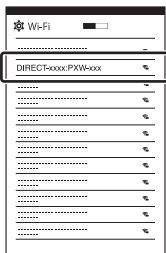

#### 💡 Tip

- The next time that you want to connect to the camcorder, select the camcorder in the device list in the Connect menu, and select [Connect].

### 4 Return to the Home screen, then start “Content Browser Mobile.”

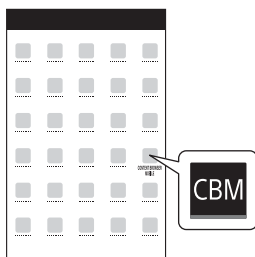

## Connecting without using the NFC function (iPhone/iPad)

### 1 Select [Settings] on the iPhone or iPad, then select [Wi-Fi] and the SSID (displayed on the camcorder).

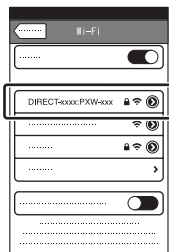

### 2 Input the password displayed on the camcorder (first time only).

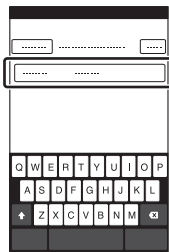

**3** Confirm connection to the SSID displayed on the camcorder.

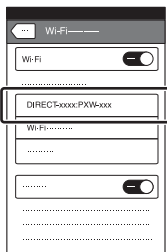

**4** Return to the Home screen, then start "Content Browser Mobile."

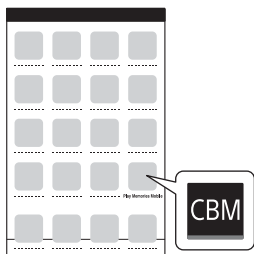



## Configuring a wireless LAN

You can connect the camcorder to a network using a wireless LAN.

### Selecting and registering an access point

You can connect the camcorder and an access point using a wireless LAN.

**1** Press the MENU button.

**2** Select  (NETWORK SET) → [Wi-Fi SET] → [ACCESS POINT SET] with the /SET button.

After a short delay, a list of access points that can be connected is displayed.

**3** Select an access point to register.

If an access point you want to register is not displayed, select [Manual setting] and configure settings manually (p. 84).

**4** Enter the password, and select [Next].

Password entry is not required for access points that do not display .

**5** Configure the access point settings.

**IP address**

Select the IP address configuration method.

When [Manual] is selected, enter the IP address configuration items displayed on the screen, and select [OK].

## Priority Connection

Select whether to configure connection priority for access points.

### 💡 Tip

- Selecting [DNS server setting] on the IP ADDRESS SET screen will display the DNS server setting screen.

---

## 6 Select [Register].

- Connection to the access point is initiated.
- [Registered.] appears when the access point is registered successfully. The SSID of the registered access point is also displayed.

---

## 7 Select [OK] → [X], and press the MENU button to close the menu screen.

### Registering an access point using the WPS function

You can register an access point quickly if the access point supports the WPS function.

---

## 1 Turn on the access point.

---

## 2 Turn on the camcorder.

---

## 3 Press the MENU button.

---

## 4 Select (NETWORK SET) → [Wi-Fi SET] → [WPS] with the /↓/↔/SET button.

- After a short delay, the following screen appears.

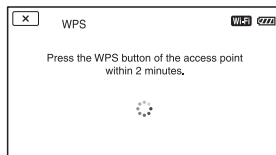

---

## 5 Press the WPS button of the access point within the next two minutes.

- For details about the WPS button function, refer to the manual for the access point.
- Connection to the access point is initiated.
- [Registered.] appears when the access point is registered successfully. The SSID of the registered access point is also displayed.
- A message is displayed on the screen if the access point could not be connected. Select [OK], then repeat the procedure after selecting [WPS] in step 4.

---

## 6 Select [OK] → [X], and press the MENU button to close the menu screen.

---

### 🔗 Notes

- For details about the functions and settings supported by your access point, refer to the manual for the access point or contact the access point administrator.

## Configuring a wireless LAN (Continued)

- The camcorder and access point may not connect or the distance between them for successful communication may be short, depending on the surrounding environment, such as obstacles and walls, and the radio wave conditions. Move the camcorder or otherwise reduce the distance between the camcorder and the access point.

### Registering an access point using the WPS PIN method

You can register an access point by entering the PIN code of the access point.

#### 1 Press the MENU button.

#### 2 Select (NETWORK SET) → [Wi-Fi SET] → [ACCESS POINT SET] with the ///SET button.

After a short delay, a list of access points that can be connected is displayed.

#### 3 Select [Manual setting] → [WPS PIN].

##### Tip

- If ten access points have been registered in the camcorder, another access point cannot be registered and a message appears. Select [Delete], and delete any access points that are no longer required.

#### 4 Enter the PIN code displayed on the camcorder screen, within two minutes, to the access point to which to connect.

- Connection to the access point is initiated.

- [Registered.] appears when the access point is registered successfully. The SSID of the registered access point is also displayed.

---

#### 5 Select → , and press the MENU button to close the menu screen.

---

##### Notes

- For details about the functions and settings supported by your access point, refer to the manual for the access point or contact the access point administrator.
- The camcorder and access point may not connect or the distance between them for successful communication may be short, depending on the surrounding environment, such as obstacles and walls, and the radio wave conditions. Move the camcorder or otherwise reduce the distance between the camcorder and the access point.

### Registering an access point manually

#### 1 Press the MENU button.

#### 2 Select (NETWORK SET) → [Wi-Fi SET] → [ACCESS POINT SET] with the ///SET button.

After a short delay, a list of access points that can be connected is displayed.

#### 3 Select [Manual setting] → [Manual regist.].

## Note

- If ten access points have been registered in the camcorder, another access point cannot be registered and a message appears. Select [Delete], and delete any access points that are no longer required.

## 4 Enter the SSID on the displayed screen, and select [Next].

## 5 Select the security method.

If [WEP] or [WPS] is displayed, enter the password on the displayed screen, and select [Next].

## 6 Configure the access point settings.

### IP address

Select the IP address configuration method.

When [Manual] is selected, enter the IP address configuration items displayed on the screen, and select [OK].

### Priority Connection

Select whether to configure connection priority for access points.

## Tip

- Selecting [DNS server setting] on the IP ADDRESS SET screen will display the DNS server setting screen.

## 7 Select [Register].

- Connection to the access point is initiated.
- [Registered.] appears when the access point is registered successfully. The SSID of the registered access point is also displayed.

## 8 Select [OK] → [X], and press the MENU button to close the menu screen.

## Changing the device name

### 1 Press the MENU button.

### 2 Select (NETWORK SET) → [Wi-Fi SET] → [EDIT DEVICE NAME] with the ////SET button.

“Wi-Fi Direct” and other devices appear.

To rename a device, use the following procedure to enter a name from the keyboard.

### How to use the keyboard

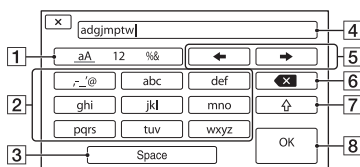

Screen items	Functions
1 Switch character type	Characters switch between alphabetical letters, numerals and symbols.
2 Keyboard	Characters are displayed in the order they are selected.
3 Space	Enters a space.
4 Input box	Entered characters are displayed.

## Configuring a wireless LAN (Continued)

Screen items	Functions
5 Move cursor	Moves the cursor in the input box to the left or right
6 Delete	Deletes the character preceding the cursor
7 ↕	Switches between uppercase and lowercase alphabetical letters
8 OK	Confirms an input operation

To cancel character input midway, press **X**.

## Configuring a wired LAN

You can connect the camcorder to a network using a wired LAN.

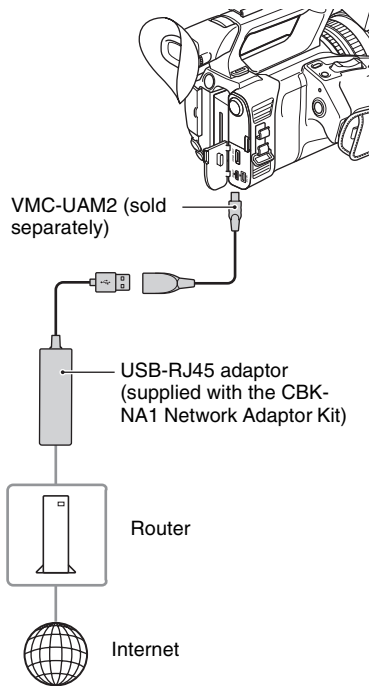

### Note

- Turn the power off before attaching or removing the VMC-UAM2 and USB-RJ45 adaptor.





**1** Attach the VMC-UAM2 (sold separately) to the multi/micro USB jack on the camcorder.

**2** Attach a USB-RJ45 adaptor (sold separately) to the VMC-UAM2, and then connect to the router using a LAN cable.

---

**3** Press the MENU button.

---

**4** Select  (NETWORK SET) → [WIRED LAN SET] → [IP ADDRESS SET] with the ////SET button.

---

**5** Configure the access point settings.

#### IP address

Select the IP address configuration method.

When [Manual] is selected, enter the IP address configuration items displayed on the screen, and select [OK].

#### Tip

- Selecting [DNS server setting] on the IP ADDRESS SET screen will display the DNS server setting screen.

## Using the streaming function (STREAMING)

You can connect the camcorder to a network and stream a movie in real-time to external devices.

### Streaming formats

There are limitations on the size of the original file movie and the streaming movie. For details, see “Streaming supported formats” (p. 132).

### Configuring streaming (preset registration)

You configure streaming settings and register them using PRESET beforehand to distribute a stream using those settings. The following items can be configured.

#### SIZE

Select the image size for streaming.

- 1280×720
- 640×360

#### Tip

- Select a size of “640×360” for increased streaming distribution stability.

#### DESTINATION SET





Configure the streaming distribution destination.

- **Host Name:** IP address or host name of the receiver
- **Port:** Port number used for streaming on the receiver

---

**1** Press the MENU button.

---

**2** Select  (NETWORK SET) → [STREAMING] → desired PRESET number → configuration item with the ////SET button.

**3** Select/set the setting value.

**4** Press the MENU button to return to the shooting screen.

### Streaming distribution

You can distribute a stream of the movie, while shooting, using the connected network.

**1** Check that the network connection settings are successful (p. 82).

**2** Press the MENU button.

**3** Select  (NETWORK SET) → [STREAMING] → [EXECUTE] → network connection method.

- The network connection starts.



- To cancel streaming, press the MENU button or press the ASSIGN button assigned with the [STREAMING] function and select [X].
- When connection is successful,  appears on the screen and the camcorder is ready to start streaming.

**4** Press the THUMBNAIL button to start streaming distribution.

- The screen icon changes to .

**5** Press the THUMBNAIL button again to stop streaming distribution.

### Tips

- You can assign [STREAMING] to an ASSIGN button (p. 62). Pressing the ASSIGN button with the assigned function displays the network connection setup screen.
- You can assign [STREAM OPERATION] to an ASSIGN button. Pressing the ASSIGN button with the assigned function starts/stops streaming distribution (p. 62).
- To simultaneously record movies to memory card and distribute a stream, start recording after the camcorder is in streaming standby state.
- If an error occurs during streaming distribution standby or during streaming distribution, a message appears. If [RECONNECT] appears, selecting it will attempt to reconnect the camcorder. Selecting [END] will disconnect the camcorder. Repeat the procedure from step 1 to reconnect.

### Notes

- The streaming function is not available when using the following functions.
  - During playback
  - During thumbnail display
  - In the following formats when the file format is AVCHD:
    - 1080/60p, 1080/50p, 720/60p, 720/50p
  - In the following formats when the file format is XAVC QFHD:
    - 2160/30p 100Mbps, 2160/24p 100Mbps, 2160/25p 100Mbps
- The following functions are not available when the streaming function is on.
  - Slow & Quick Motion (including High Frame Rate)
  - Proxy recording



- FACE DETECTION
- COLOR BAR
- DATE REC
- SIMULTANEOUS REC/RELAY REC
- Only wired LAN connection is supported when [AIRPLANE MODE] is set to [ON].
- Streaming distribution transmits the raw video and audio data via the Internet. Accordingly, the data may be disclosed to other parties.
- Check that the streaming data is being received by the receiving device.
- Data may be transmitted to a third party if the address or other settings are configured incorrectly.
- Some frames may not be played, depending on the network status.
- The image quality of fast-changing scenes may be adversely affected.

## Camcorder operation during streaming

The following functions are enabled during streaming. Use the hardware switches and buttons to control the camcorder. Operation from the menu is not supported.

- Zoom
- Focusing
- To adjust the output audio level, adjust the input level using the AUDIO LEVEL dial.
- Exposure adjustment (iris, gain and shutter speed)
- White balance

# Using the FTP transfer function

When the camcorder is connected to a network, you can transfer recorded movie files directly to an FTP server. Proxy files can also be transferred.

## Registering an FTP server

An FTP server must be registered in order to use FTP transfer. Up to three servers can be registered. This section describes the registration of FTP SERVER1 as an example.

### 1 Press the MENU button.

### 2 Select (NETWORK SET → [FTP TRANSFER] → [FTP SERVER1] with the ///SET button.

The FTP SERVER1 setup screen appears.

### 3 Select the item name of each setting, and enter the settings for FTP SERVER1.

Enter using the keyboard, then select [OK].

#### Tip

- For details about the keyboard input method, see page 85.

#### DISPLAY NAME

Enter the display name of the FTP server to register.

#### DESTINATION SET

- **Host Name:** Host name or IP address of the server
- **Secure Protocol:** Enable/disable secure FTP transfer
- **Port:** Port number of the FTP server
- **Directory:** Transfer destination directory

## Using the FTP transfer function (Continued)

### USER INFO SET

User name and password

#### Note

- It is recommended that [Secure Protocol] be set to [ON]. If set to [OFF], the user name, password, and movie file data may be disclosed to other parties if communication with the FTP server is intercepted or if connected to an unintended FTP server.

### Selecting an FTP server

Select an FTP server to use for FTP transfer from the list of registered FTP servers.

#### 1 Press the MENU button.

#### 2 Select (NETWORK SET) → [FTP TRANSFER] → [FTP SERVER SELECT] with the //SET button.

#### 3 Select the desired server.

### Using FTP transfer

You can transfer files by FTP using the connected network.

#### 1 Check that the network settings are configured (p. 82).

#### 2 Press the THUMBNAIL button.

#### 3 Select the media, where the files you want to transfer are stored, and the file format on the thumbnail screen.

#### 4 Press the MENU button.

#### 5 Select (NETWORK SET) → [FTP TRANSFER] → [EXECUTE] → network connection method with the //SET button.

- The network connection starts.
- The thumbnail screen appears when connection to the FTP server is successful.
- If the file format is set to [XAVC QFHD], [XAVC HD], [MPEG HD 422], or [MPEG HD 420] in step 3, select the file to transfer using “Main” and “PROXY.”

#### Tip

- You can assign this function to an ASSIGN button (p. 62).

#### 6 Select the thumbnail of the file you want to transfer, and select .

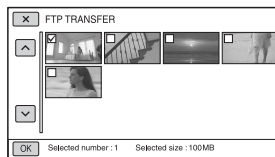

- Up to 100 files can be selected.
- Press the DISPLAY button to preview the image.
- appears on the thumbnail of files that have a proxy file.

## 7 Select whether to turn the camcorder off (YES) or not (NO) automatically when the FTP transfer is completed.

- File transfer starts.

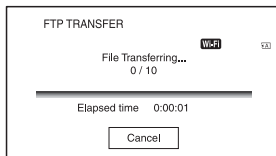

- To cancel the transfer, select [Cancel].
- If [YES] was selected in step 7, the camcorder turns off automatically when the transfer is completed. If [NO] was selected, select [OK]. You can also continue transferring files.

### Notes

- Only files that were recorded by the camcorder can be transferred using FTP.
- Do not exchange a memory card after starting a file transfer.
- FTP transfer is not available in shooting mode. To start a file transfer, first press the THUMBNAIL button to switch to playback mode.
- Only wired LAN connection is supported when [AIRPLANE MODE] is set to [ON].

## Checking FTP transfer results

You can check whether all files have been transferred. If the camcorder is configured to turn off automatically after transfer is completed, it is recommended that you check the transfer results.

## 2 Select (NETWORK SET) → [FTP TRANSFER] → [FTP RESULT].

- The transfer results are displayed.
- The displayed transfer results contains the following items.

### Date

Date and time of transfer start

### Number of Contents

Number of transferred contents / total number of transfer contents

### Result

Transfer result

## 1 Press the MENU button.

# Importing a root certificate

If [Secure Protocol] is set to [ON] for FTP transfer, a root certificate for authentication of the FTP server is required. The camcorder contains a built-in root certificate, which can also be updated. To update the root certificate, save the certificate on a memory card and then import the certificate from the memory card.

---

## 1 Write the root certificate to a memory card.

Write the certificate in PEM format with a “certification.pem” file name to the root directory of the memory card.

---

## 2 Insert the memory card with the root certificate into memory card slot A of the camcorder.

---

## 3 Press the MENU button.

---

## 4 Select (NETWORK SET) → [ROOT CERTIFICATE] → [OK] with the ///SET button.

- The root certificate starts importing.
- The certificate is imported successfully when “Completed.” appears. Select **OK** to dismiss the screen.

---

### Notes

- Do not eject the memory card while a certificate is being imported.
- Resetting network settings (p. 93) will delete the root certificate imported from the memory card, and will initialize the root certificate of the camcorder.

### Note on wireless network function

We assume no responsibility whatsoever for any damage caused by unauthorized access to, or unauthorized use of, destinations loaded on the camcorder, resulting from loss or theft.

### Security in the use of wireless LAN devices

- To avoid hacking, access by malicious third parties, and other vulnerabilities, confirm that the wireless LAN is always secure.
- It is very important to set up security on a wireless LAN.
- If a problem occurs due to inadequate security measures or due to foreseeable circumstances, Sony Corporation is not responsible for any resulting damage.

# Resetting network settings

The following settings are reset when resetting network settings.

- SSID/password for smartphone operation (p. 80)
- Streaming settings (p. 87)
- FTP transfer settings (p. 89)
- FTP transfer result (p. 91)
- Wired LAN settings (p. 86)
- Access point settings (page 82 to 85)
- Device name (p. 85)

---

**1** Press the MENU button.

---

**2** Select  (NETWORK SET) → [NETWORK RESET] → [OK] with the ////SET button.

---

## Protecting movies (Protect)

Protect movies to avoid deleting them by mistake.

**1** Press the MENU button when the THUMBNAIL screen is displayed.

**2** Press the  $\uparrow/\downarrow/\leftarrow/\rightarrow$ /SET button, then select  $\square$  (EDIT)  $\rightarrow$  [PROTECT].

**3** Select the movie to be protected.

✓ is displayed on the selected images.

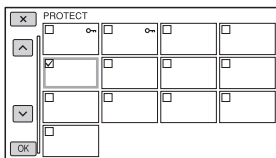

- Press the DISPLAY button to preview the image. Press  $\square$  to return to the previous screen.
- You can select up to 100 images at one time.

**4** Select  $\square$  (OK), successively, according to the screen display.

### To undo the protection

Select a movie marked with ✓ in step 3.

✓ disappears.

## Dividing a movie

You can divide a movie at a designated point.

**1** Press the MENU button while playing back movies.

**2** Press the  $\uparrow/\downarrow/\leftarrow/\rightarrow$ /SET button, then select  $\square$  (EDIT)  $\rightarrow$  [DIVIDE].

**3** Select  $\square$  at the point where you want to divide.

After you select the point with  $\square$ , make fine adjustment with these buttons.

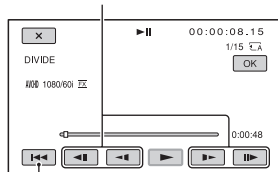

Returns to the beginning of the selected movie.

**4** Select  $\square$  (OK), successively, according to the screen display.

### Notes

- Dividing movies is supported for AVCHD only.
- You cannot restore movies once they are divided.
- Do not remove the battery pack, the AC Adaptor or the memory card that contains the movies from your camcorder during the operation. It may damage the memory card.
- A slight time difference may occur between the point where you touch  $\square$  and the actual dividing point, as your camcorder selects the dividing point based in about half-second increments.

# Deleting movies

You can free media space by deleting movies from a memory card.

## Notes

- You cannot restore images once they are deleted.
- Do not remove the battery pack, the AC Adaptor, or the memory card from your camcorder during the operation. It may damage the memory card.
- You cannot delete protected movies. Undo the protection of the movies before you try to delete them (p. 94).
- Save important movies beforehand.

## Tip

- To delete all data recorded on a memory card and recover all the recordable space, format the media (p. 96).

---

**4** Select , successively, according to the screen display.

---

---

**1** Press the MENU button when the THUMBNAIL screen is displayed.

---

**2** Press the  $\uparrow/\downarrow/\leftarrow/\rightarrow$ /SET button, then select  (EDIT)  $\rightarrow$  [DELETE].

---

**3** Select a move to delete.

- ✓ is displayed on the selected images.

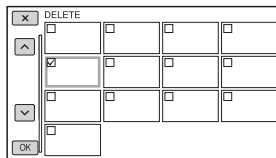

- Press the DISPLAY button to preview the image. Press  to return to the previous screen.
- You can select up to 100 images at one time.
-  appears at the upper right corner on the thumbnail of protected images.
- No checkbox appears on the thumbnail of protected images.

# Formatting a memory card

Formatting deletes data from the memory card to recover recordable free space.





## 🔌 Notes

- Connect your camcorder to the wall outlet (wall socket) using the supplied AC Adaptor to prevent your camcorder from running out of power during the operation.
- To avoid the loss of important images, you should save them before formatting a memory card.
- Protected movies are also deleted.

---

**1 Press the MENU button.**

---

**2 Press the ////SET button, then select  (OTHERS) → [MEDIA FORMAT].**

---

**3 Select the memory card to be formatted.**

---

**4 Select , successively, according to the screen display.**

---

## 🔌 Note

- While [Executing...] is displayed, do not turn off the camcorder, do not operate any buttons on the camcorder, disconnect the AC Adaptor, or remove the memory card from your camcorder. (The access lamp is lit or flashing during formatting.)

# Deleting all data from the memory card completely

If a memory card is used repeatedly, garbage data accumulate which may prevent the image data from being written at the fixed speed. In this case, recording may stop suddenly.

If this happens, empty the memory card to avoid the writing error. Emptying the memory card can erase more data than ordinary formatting.

## 🔌 Notes

- If you perform this operation, all stored data are deleted. To avoid the loss of important images, you should save them before formatting a memory card.
- You cannot perform this operation unless you connect the AC Adaptor to the wall outlet (wall socket).
- Disconnect all cables except the AC Adaptor. Do not disconnect the AC Adaptor during the operation.
- Do not apply any vibrations or shocks to your camcorder during this operation.





---

**1 Connect your camcorder to the wall outlet (wall socket) using the AC Adaptor (supplied) (p. 22).**

---

**2 Press the MENU button.**

---

**3 Press the ////SET button, then select  (OTHERS) → [MEDIA FORMAT].**

---

**4 Select the memory card to delete.**  
The deletion screen appears.

---

**5 Select [Empty] → .**

---



# Repairing the image database file

## 🔊 Notes

- It may take from several minutes to several hours to empty a memory card, depending on the capacity. You can check the actual time required on the LCD screen.
- If you stop the operation while [Executing...] is displayed, be sure to complete the operation by performing [MEDIA FORMAT] or emptying before you use the memory card next time.

## 💡 Tip

- To prevent a data write error from occurring on the recording media, empty the media data from the camcorder before you start recording. By deleting all data using the [Empty] operation instead of the ordinary [MEDIA FORMAT] operation, you can minimize potential media write errors that might occur when recording.

This function checks the database information and the consistency of movies on the memory card, and repairs any inconsistencies found.

## 🔊 Note

- Connect your camcorder to the wall outlet (wall socket) using the supplied AC Adaptor to prevent your camcorder from running out of power during the operation.

---

**1 Press the MENU button.**

---

**2 Press the  $\uparrow/\downarrow/\leftarrow/\rightarrow$ /SET button to select  (OTHERS) → [REPAIR IMAGE DB FILE].**

---

**3 Select the memory card for which you want to check the database file.**

---

**4 Select .**

The database file check starts. Select  and quit the database file check if no inconsistency is found.

---

**5 Select , successively, according to the screen display.**

---

## 🔊 Note

- If you stop the operation while “Repairing the image database file.” is displayed, be sure to complete the operation as described above before you use the memory card next time.

# Operating the menu

You can change various settings or make detailed adjustments using the menu items displayed on the LCD screen.

MENU button

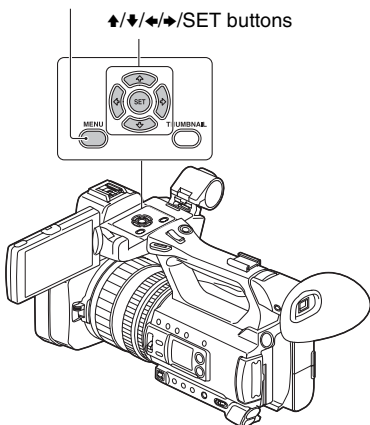

## 1 Press the MENU button.

The menu screen appears.

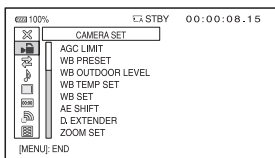

## 2 Press the ↑/↓/←/→/SET button, select the desired menu icon, then press the button again.

- CAMERA SET (p. 99)
- REC/OUT SET (p. 102)
- AUDIO SET (p. 104)
- DISPLAY SET (p. 107)
- TC/UB SET (p. 110)
- NETWORK SET (p. 111)
- OTHERS (p. 113)
- EDIT (p. 114)

## 3 Press the ↑/↓/←/→/SET button, select the item that you want to set, then press the button again.

## 4 Press the ↑/↓/←/→/SET button, select the desired setting, then press the button again.

## 5 Press the MENU button to hide the menu screen.

To return to the previous screen, select [↩ RETURN].

### ⚙ Notes

- The available menu items vary depending on the context of your camcorder during recording or playback.
- Items and setting values not available due to other settings, are grayed out.

# Menu items





The function and setting value of each menu item are as follows.  
The default settings are marked with bold text.





The display sequence of menu items may vary from the device.

## CAMERA SET menu

CAMERA SET		
Menu item	Sub-items/Settings	Description
<b>AGC LIMIT</b>	<b>OFF</b> , 24dB to 0dB	Selects the upper limit for the Auto Gain Control (AGC). <ul style="list-style-type: none"><li>• This function is not effective while you adjust the gain manually.</li></ul>
<b>WB PRESET</b>	<b>OUTDOOR</b> , INDOOR, MANU WB TEMP	Selects a preset white balance setting (p. 43).
<b>WB OUTDOOR LEVEL</b>	-7 to +7 ( <b>0</b> )	Sets the offset value when the preset white balance is set to [OUTDOOR]. Shifts to blue when negative, and to red when positive.
<b>WB TEMP SET</b>	2300K to 15000K ( <b>6500K</b> )	Sets the color temperature value when the preset white balance is set to [MANU WB TEMP].
<b>WB SET</b>	-	Adjusts white balance for the shooting environment using one-push button (p. 44).
<b>AE SHIFT</b>	ON/OFF <b>OFF</b> , ON	Turns the AE shift function on/off.
	LEVEL -2.0EV to +2.0EV ( <b>0EV</b> )	Adjusts the brightness. <ul style="list-style-type: none"><li>• This function is not effective while you adjust the iris, shutter speed, gain all manually.</li></ul>
<b>D. EXTENDER</b>	<b>OFF</b> , ON	Turns the digital extender (function that provides double the zoom) on/off. <ul style="list-style-type: none"><li>• This function is not available for XAVC QFHD.</li></ul>

## Menu items (Continued)

CAMERA SET		
Menu item	Sub-items/Settings	Description
<b>ZOOM SET</b>	ZOOM TYPE <b>OPTICAL ZOOM ONLY</b> , ON[CLEAR IMAGE ZOOM], ON[DIGITAL ZOOM]	Selects the type of zoom used when operating the zoom lever. OPTICAL ZOOM ONLY: Uses optical zoom only. ON[CLEAR IMAGE ZOOM]: Uses clear image zoom in addition to optical zoom. <ul style="list-style-type: none"> <li>• Clear image zoom is a zoom function that features little or no degradation in image quality.</li> </ul> ON[DIGITAL ZOOM]: Uses digital zoom in addition to optical zoom and clear image zoom. Image quality deteriorates within the range where $\text{pQ}$ is displayed. <ul style="list-style-type: none"> <li>• The face detection function is disabled when using clear image zoom and digital zoom.</li> </ul>
	HANDLE ZOOM ZOOM OPERATION <b>ON</b> , OFF	Sets whether to enable the handle zoom.
	ZOOM SPEED 1 to 8 ( <b>3</b> )	Adjusts the zoom speed of the handle zoom.
 <b>STEADYSHOT</b>	<b>STANDARD</b> , ACTIVE, OFF	Sets the image stabilization to reduce camera shake when shooting. STANDARD (  ): Uses image stabilization function. ACTIVE (  ): Uses strong image stabilization effect. <ul style="list-style-type: none"> <li>• When [ACTIVE] is selected, the angle of view shifts 1.08 times toward the telephoto side.</li> </ul> OFF (  ): Does not use image stabilization function. <ul style="list-style-type: none"> <li>• This setting is recommended when you use a tripod.</li> </ul>
	<b>CONVERSION LENS</b>	<b>OFF</b> , WIDE CONVERSION
<b>S&amp;Q MOTION</b>	HIGH FRAME RATE <b>OFF</b> , ON	Sets slow-motion recording at high frame rate (HFR) (p. 58).
	REC FORMAT (See page 60.)	Sets Slow & Quick Motion recording (p. 58).
	REC MEDIA 1 to 60fps ( <b>60</b> fps)	

<b>CAMERA SET</b>		
Menu item	Sub-items/Settings	Description
<b>AUTO MODE SET</b>	<b>AUTO</b> , INTELLIGENT AUTO, SCENE SELECTION	Sets auto mode to optimize settings to suit the scene to record (p. 48).
<b>SCENE SELECTION SET</b>	NIGHT SCENE, SUNRISE&SUNSET, FIREWORKS, LANDSCAPE, <b>PORTRAIT</b> , SPOTLIGHT, BEACH	Sets the scene to use when auto mode is set to [SCENE SELECTION] (p. 48).
<b>AUTO BACK LIGHT</b>	<b>OFF</b> , ON	Turns auto backlight compensation on/off.
<b>FACE DETECTION</b>	<b>OFF</b> , ON	Turns face detection and the facial focus function on/off (p. 35).
<b>VIDEO LIGHT</b>	<b>POWER LINK</b> , REC LINK, REC LINK+STBY, AUTO	<p>Sets the lighting method for a video light (sold separately) attached to the multi-interface shoe.</p> <p><b>POWER LINK</b> : Video light turns on/off when the camcorder power is turned on/off.</p> <p><b>REC LINK</b> : Video light turns on/off when the camcorder starts/stops recording.</p> <p><b>REC LINK+STBY</b> : Video light turns on or switches to standby when the camcorder starts/stops recording.</p> <p><b>AUTO</b> : Light turns on/off automatically.</p>
<b>NIGHTSHOT LIGHT</b>	<b>ON</b> , OFF	<p>Turns the infrared light source for shooting in NIGHTSHOT mode (p. 49) on/off.</p> <p>Infrared lighting allows you to record clearer images in dark conditions.</p> <ul style="list-style-type: none"> <li>• Make sure that your finger does not cover the NIGHTSHOT light emitter (p. 10) when shooting.</li> <li>• The light is effective up to a distance of approximately 3 meters (10 feet).</li> </ul>

## Menu items (Continued)

CAMERA SET		
Menu item	Sub-items/Settings	Description
<b>COLOR BAR</b>	ON/OFF <b>OFF</b> , ON	Displays and records color bars, and outputs audio tone signals. <ul style="list-style-type: none"> <li>• This function is automatically set to [OFF] when you switch the format, execute a function with the MENU button, or turn off the camcorder.</li> <li>• The [COLOR BAR] setting cannot be changed during recording or during focus magnifier operation.</li> </ul>
	TONE <b>OFF</b> , ON	Sets whether to output an audio tone signal (1 kHz: full bit, -20dB (when [60i] is selected), -18dB (when [50i] is selected)) during color bar display. When turned off, the audio from the microphone is recorded during color bar display.
<b>PICTURE PROFILE</b>	See page 50.	Selects a picture profile with desired adjustments for gamma, detail, and other settings (p. 50).

## REC/OUT SET menu

REC/OUT SET		
Menu item	Sub-items/Settings	Description
<b>REC SET</b>	FILE FORMAT XAVC QFHD, <b>XAVC HD</b> , MPEG HD 422, MPEG HD 420, AVCHD	Selects the file format (p. 37).
	REC FORMAT (See page 37.)	Sets the recording format (p. 37).
	SIMUL/RELAY REC <b>OFF</b> , SIMULTANEOUS REC, RELAY REC	Sets relay recording (p. 31) or simultaneous recording (p. 32) using multiple memory cards.
	REC BUTTON SETTING (See page 32.)	Sets the operation of the START/STOP button and handle record button when [SIMULTANEOUS REC] is selected (p. 32).
	PROXY REC MODE ON/OFF <b>OFF</b> , ON	Sets proxy recording (p. 39).
	SIZE <b>1280x720</b> , 640x360	

## REC/OUT SET

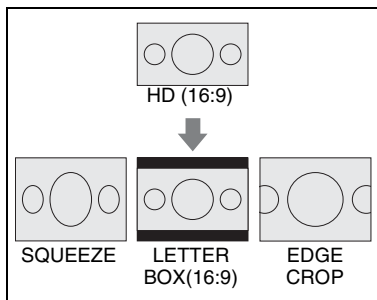

Menu item	Sub-items/Settings	Description
<b>VIDEO OUT</b>	OUTPUT SELECT	Selects the output destination for the video signal.
	OUTPUT SELECT SDI, <b>HDMI</b> , VIDEO	Selects the output destination for the video signal when recording in XAVC QFHD (p. 38).
	QFHD REC OUTPUT <b>VF/LCD PANEL</b> , EXTERNAL OUTPUT	
	SDI/HDMI	Selects the resolution of the output signal from the SDI OUT/HDMI OUT jacks.
	When [60i] is selected: 2160p/1080p/480i, 2160p/720p/480i, 2160p/1080i/480i, 1080p/480i, 720p/480i, <b>1080i/480i</b> , 480p, 480i When [50i] is selected: 2160p/1080p/576i, 2160p/720p/576i, 2160p/1080i/576i, 1080p/576i, 720p/576i, <b>1080i/576i</b> , 576p, 576i	<ul style="list-style-type: none"> <li>• See page 72 for the format of the output signal for each type of connection cable.</li> </ul>
24p/30p OUTPUT <b>24p/30p</b> , 24PsF/30PsF, 60p(Pull Down)	Sets the output format when [REC FORMAT] is set to 24p or 30p. <ul style="list-style-type: none"> <li>• Available when [60i] is selected only.</li> <li>• See page 72 for the format of the output signal.</li> </ul>	
25p OUTPUT <b>25p</b> , 25PsF, 50p(Pull Down)	Sets the output format when [REC FORMAT] is set to 25p. <ul style="list-style-type: none"> <li>• Available when [50i] is selected only.</li> <li>• See page 72 for the format of the output signal.</li> </ul>	
DOWN CONVERT TYPE <b>SQUEEZE</b> , LETTER BOX (16:9), EDGE CROP	Sets the video output signal format. Selects the format when video is output at 480p/480i or 576p/576i with 4:3 aspect ratio.	





## Menu items (Continued)

REC/OUT SET		
Menu item	Sub-items/Settings	Description
	HDMI TC OUTPUT <b>OFF, ON</b>	Sets whether to output time code to other professional-use devices, using HDMI.
	SDI/HDMI REC CONTROL <b>OFF, ON</b>	When the camcorder is connected to an external recorder, sets whether the external recorder automatically starts/stops recording based on the camcorder's operation.

## AUDIO SET menu

AUDIO SET		
Menu item	Sub-items/Settings	Description
<b>VOLUME</b>	–	Adjusts the volume.
<b>AVCHD AUDIO FORMAT</b>	<b>LINEAR PCM, DOLBY DIGITAL</b>	Switches the recording audio format. LINEAR PCM (  LPCM ): Records in linear PCM format. DOLBY DIGITAL (  DolbyD ): Records in Dolby Digital format.
<b>AUDIO LIMIT</b>	<b>OFF, ON</b>	Turns the CH-1/CH-2 audio clipping function on/off. • Available only when the AUTO/MAN (CH-1/CH-2) switch is set to “MAN.”
<b>HEADPHONE OUT</b>	<b>STEREO, MIX MONO, CH1, CH2</b>	Sets the headphone sound (p. 47).
<b>INT MIC SET</b>	INT MIC SENS <b>NORMAL, HIGH</b>	Sets the audio recording sensitivity of the internal microphone. NORMAL: Sensitivity generally used for professional-use devices. HIGH: Sensitivity generally used for consumer-use devices.
	INT MIC WIND <b>OFF, ON</b> (  )	Sets whether to attenuate low tone input sound in the internal microphone to reduce wind noise.



AUDIO SET		
Menu item	Sub-items/Settings	Description
<b>XLR SET</b>	INPUT CH SELECT INPUT1/INPUT1, <b>INPUT1/INPUT2</b>	Selects the signals for recording on CH-1 and CH-2 (p. 46). INPUT1/INPUT1: Records the input on INPUT1 signal to both CH-1 and CH-2. INPUT1/INPUT2: Records the INPUT1 signal to CH-1, and the INPUT2 signal to CH-2.
	XLR AGC LINK <b>SEPARATE, LINKED</b>	Links/unlinks the AGC (Auto Gain Control) of CH-1 and CH-2 when using an external microphone. SEPARATE: Unlinks AGC (CH-1 and CH-2 are recorded with separate AGC). LINKED (  ): Links AGC (CH-1 and CH-2 are recorded with linked AGC, like stereo). A  appears on the status check screen. • Available when the AUTO/MAN switches for both CH-1/CH-2 are set to "AUTO" and the same source "LINE/MIC/MIC+48V" is selected on both INPUT1 and INPUT2 (p. 46).





## Menu items (Continued)

AUDIO SET		
Menu item	Sub-items/Settings	Description
	INPUT1 TRIM –18dB to +12dB ( <b>0dB</b> )	Adjusts the input signal level when recording the signal from the INPUT1 jack or INPUT2 jack. <ul style="list-style-type: none"> <li>If the recording level is set to “AUTO” and INPUT TRIM is set to [0dB], a –48 dBu input will be recorded at the reference recording level (–48 dBu corresponds to 0 dB level).</li> </ul> <p>For example, if a microphone with –30 dB sensitivity (0 dB = 1 V/Pa at 1 kHz) is connected and a 1 kHz 74 dB SPL sound pressure level is input (microphone output is –48 dBu), set INPUT TRIM to [0dB]. If using a microphone with –36 dB sensitivity, setting INPUT TRIM to [+6dB] will compensate for the difference in sensitivity from a microphone with –30 dB sensitivity.</p> <ul style="list-style-type: none"> <li>The INPUT TRIM function adjusts the input level of external microphones. For microphones with high sensitivity or to record high-level audio, adjust in the negative direction. For microphones with low sensitivity or to record low-level audio, adjust in the positive direction.</li> <li>Distortion of high-volume audio may occur in the input stage or the recording stage. To counter distortion of the input stage, adjust the level using the INPUT TRIM function. To counter distortion in the recording stage, reduce the overall level manually.</li> <li>If the INPUT TRIM is adjusted in the negative direction too far, the audio level from the microphone may become too small, adversely affecting the S/N ratio.</li> <li>This setting is disabled when the INPUT1 switch or INPUT2 switch is set to “LINE.”</li> </ul>
	INPUT2 TRIM –18dB to +12dB ( <b>0dB</b> )	
	INPUT1 WIND <b>OFF, ON</b>	Turns wind reduction of the INPUT1 jack or INPUT2 jack on/off.
	INPUT2 WIND <b>OFF, ON</b>	When on,  appears on the status check screen. <ul style="list-style-type: none"> <li>This setting is disabled when the INPUT1 switch or INPUT2 switch is set to “LINE.”</li> </ul>

## DISPLAY SET menu

DISPLAY SET		
Menu item	Sub-items/Settings	Description
<b>HISTOGRAM</b>	<b>OFF</b> , ON, ON[ZEBRA POINT]	Sets whether to display a histogram. The histogram displays the luminance distribution that shows how many pixels for each brightness level exist in the image. OFF: Does not display a histogram. ON: Displays a histogram. A line appears at the 100% position, and the color of the zone above the line changes. ON[ZEBRA POINT]: The histogram shows the point where the zebra pattern appears. A line is displayed at the brightness level set with [ZEBRA].
	<b>ZEBRA</b>	ON/OFF <b>OFF</b> , ON
	LEVEL 70 to 100, 100+ ( <b>70</b> )	Selects the brightness level.
<b>PEAKING</b>	ON/OFF <b>OFF</b> , ON	Sets whether to display peaking (outline enhancement in images). • You can focus more easily using this function in combination with the focus magnifier function (p. 34). • The peaking is not recorded with the image.
	COLOR <b>WHITE</b> , RED, YELLOW	Selects the peaking color.
	LEVEL HIGH, <b>MIDDLE</b> , LOW	Selects the peaking sensitivity.

## Menu items (Continued)

DISPLAY SET		
Menu item	Sub-items/Settings	Description
<b>MARKER</b>	ON/OFF <b>OFF</b> , ON	Sets whether to display markers. You can display multiple types of markers at the same time. <ul style="list-style-type: none"> <li>Markers are not recorded on the memory card.</li> <li>During marker display, only the time code, zebra, peaking, and face detection indicators are output, even if [DISPLAY OUTPUT] is set to [ALL OUTPUT].</li> <li>You cannot display markers when using [FOCUS MAGNIFIER].</li> </ul>
	CENTER <b>ON</b> , OFF	 (Center marker)
	ASPECT <b>OFF</b> , 4:3, 13:9, 14:9, 15:9, 1.66:1, 1.85:1, 2.35:1	 (Aspect marker)
	SAFETY ZONE <b>OFF</b> , 80%, 90%	 (Safety zone)
	GUIDEFRAAME <b>OFF</b> , ON	 (Guideframe)
<b>FOCUS MAG RATIO</b>	×4.0, ×8.0, <b>×4.0/×8.0</b>	Sets the focus magnification ratio. When “×4.0/×8.0” is selected, the setting changes in the order [×4.0] → [×8.0] → [OFF] with each press of the ASSIGN5/FOCUS MAG button.
<b>CAMERA DATA DISPLAY</b>	OFF, <b>ON</b>	Sets whether to display the iris, gain, and shutter speed values.

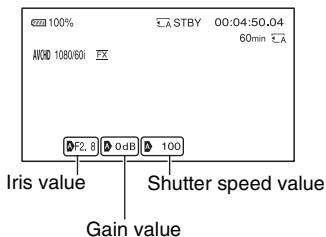

- The settings appear during manual adjustment, regardless of the setting of this function.
- A** indicates that the settings are automatically adjusted values.

DISPLAY SET		
Menu item	Sub-items/Settings	Description
<b>AUDIO LEVEL DISPLAY</b>	<b>ON, OFF</b>	Sets whether to display the audio level meters.
<b>ZOOM DISPLAY</b>	<b>BAR, NUMBER</b>	Sets whether to display the zoom position as a bar or number.
<b>FOCUS DISPLAY</b>	<b>METER, FEET</b>	Sets the display of the focus distance in meters or feet.
<b>SHUTTER DISPLAY</b>	<b>SECOND, DEGREE</b>	<p>Sets the display of the shutter speed in seconds or degrees.</p> <p>The shutter speed equal to the period that your camcorder reads image data from the image sensor is defined as 360 degrees. The degree is calculated based on this definition and displayed.</p> <ul style="list-style-type: none"> <li>• When you press the ASSIGN button to which [DATA CODE] is assigned, the shutter speed is displayed in seconds regardless of this setting.</li> <li>• If the shutter speed is more than 360 degrees, it is displayed as an integral multiple of 360 degrees (360 × 2, etc.).</li> </ul>
<b>DATA CODE</b>	<b>OFF, DATE/TIME, CAMERA DATA</b>	Selects the information that is displayed during playback.
<b>LCD BRIGHT</b>	<b>NORMAL, BRIGHT</b>	<p>Adjusts the brightness of the LCD screen.</p> <ul style="list-style-type: none"> <li>• Changes in the LCD brightness do not affect the brightness of recorded images.</li> </ul>
<b>VF COLOR TEMP.</b>	<b>-2/-1/0/+1/+2 (0)</b>	<p>Sets the color temperature of the viewfinder. Low color temperature makes the viewfinder appear reddish, and high color temperature makes it appear bluish.</p>
<b>VF/LCD PANEL</b>	<b>LCD PANEL, AUTO</b>	Switches the display in the viewfinder and LCD screen (p. 25).
<b>DISPLAY OUTPUT</b>	<b>LCD PANEL, ALL OUTPUT</b>	<p>Sets the output to display information, such as the time code.</p> <p>You can select to display information on the LCD screen only, or output the information to the HDMI OUT/VIDEO OUT jacks and the LCD screen. Zebra, peaking and the frame on the face are also output.</p> <ul style="list-style-type: none"> <li>• During marker display, only the time code, zebra, peaking, and face detection indicators are output, even if [DISPLAY OUTPUT] is set to [ALL OUTPUT].</li> <li>• You cannot display markers when using [FOCUS MAGNIFIER].</li> </ul>

## Menu items (Continued)

TC/UB SET menu		
TC/UB SET		
Menu item	Sub-items/Settings	Description
<b>TC/UB DISPLAY</b>	<b>TC</b> , U-BIT	Switches the display to time code or user bits.
<b>TC PRESET</b>	PRESET, RESET	Sets the time code (p. 57).
<b>UB PRESET</b>	PRESET, RESET	Sets the user bits (p. 57).
<b>TC FORMAT</b>	<b>DF</b> , <b>NDF</b>	<p>Switches the time code recording method when [60i] is selected. The time code is fixed to [NDF] when [50i] is selected.</p> <p>DF: Records the time code in drop frame.</p> <p>NDF: Records the time code in non-drop frame.</p> <ul style="list-style-type: none"><li>• The time code is also fixed to [NDF] when [60i] is selected and the frame rate is set to 24 in [REC FORMAT].</li><li>• Drop-frame Time code is based on 30 frames per second; however, gaps in the actual time occur during extended periods of recording as the actual frame frequency of NTSC image signals is 29.97 frames per second. Drop frame corrects this gap to make time code and actual time equal. In drop frame, the first 2 frame numbers are removed every minute except in every tenth minute. Time code without this correction is called non-drop frame.</li></ul>
<b>TC RUN</b>	<b>REC RUN</b> , <b>FREE RUN</b>	<p>Sets how the time code advances.</p> <p><b>REC RUN</b>: Advances the time code only during recording. Select this setting to record the time code sequentially from the last time code of the previous recording.</p> <ul style="list-style-type: none"><li>• Even if the time code advances in the [REC RUN] mode, the time code may not be recorded sequentially in the following cases:<ul style="list-style-type: none"><li>– When the recording format is changed.</li><li>– When the memory card is removed.</li></ul></li></ul> <p><b>FREE RUN</b>: Advances the time code regardless of operation of your camcorder.</p>

TC/UB SET		
Menu item	Sub-items/Settings	Description
<b>TC MAKE</b>	<b>PRESET</b> ,	Sets how the time code continues.
	REGENERATE	PRESET: Records a preset set time code on the memory card. REGENERATE: Reads the last recorded time code from the memory card, and starts recording with a consecutive time code. <ul style="list-style-type: none"> <li>The time code advances in [REC RUN] mode, regardless of the setting of [TC RUN].</li> </ul>
<b>UB TIME REC</b>	<b>OFF</b> , ON	Sets whether to save the actual time in user bit code. <ul style="list-style-type: none"> <li>The last 2 digits are fixed to "00" when it is set to [ON].</li> </ul>

## NETWORK SET menu

NETWORK SET		
Menu item	Sub-items/Settings	Description
<b>CTRL W/ SMARTPHONE STREAMING</b>		Enables operation with a smartphone (p. 78).
	PRESET SELECT <b>PRESET1</b> , PRESET2, PRESET3 PRESET1/PRESET2/ PRESET3 SIZE <b>640x360</b> , 1280x720 DESTINATION SET	Sets streaming (p. 87).
<b>FTP TRANSFER</b>	FTP SERVER SELECT <b>FTP SERVER1</b> , FTP SERVER2, FTP SERVER3	Selects an FTP server (p. 90).
	FTP SERVER1/FTP SERVER2/FTP SERVER3 DISPLAY NAME DESTINATION SET USER INFO SET	Registers an FTP server (p. 89).
	FTP RESULT	Checks FTP transfer results (p. 91).
<b>WIRED LAN SET</b>	IP ADDRESS SET	Configures a wired LAN (p. 86).

## Menu items (Continued)

NETWORK SET		
Menu item	Sub-items/Settings	Description
<b>Wi-Fi SET</b>	ACCESS POINT SET	<ul style="list-style-type: none"><li>• Selects and configures an access point (p. 82).</li><li>• Registers an access point using the WPS PIN method (p. 84).</li><li>• Registers an access point manually (p. 84).</li></ul>
	WPS	Registers an access point using the WPS function (p. 83).
	EDIT DEVICE NAME	Edits the device name (p. 85).
	SSID/PW RESET	Resets the connection information. When [OK] is selected, the connection information registered in order to use [CTRL W/SMARTPHONE] is reset. <ul style="list-style-type: none"><li>• If the connection information has been reset, it will be necessary to set up the smartphone again, in order to connect it to the camcorder.</li></ul>
	DISP MAC ADDRESS	Displays the camcorder's MAC address.
<b>AIRPLANE MODE</b>	<b>OFF, ON</b>	Turns airplane mode on/off. When turned on, all Wi-Fi-related settings are temporarily disabled (for when boarding a plane, etc.).
<b>ROOT CERTIFICATE</b>		Imports a root certificate (p. 92).
<b>NETWORK RESET</b>		Resets network settings (p. 93).



## OTHERS menu

### OTHERS

Menu item	Sub-items/Settings	Description
<b>STATUS CHECK</b>		Checks the settings in your camcorder (p. 69).
<b>CAMERA PROFILE</b>	MEMORY CARD A, MEMORY CARD B	Loads, saves, and deletes camera profiles. <ul style="list-style-type: none"><li>• A camera profile saves configuration settings, such as menu, picture profile, and button settings. Up to 99 profiles can be saved on a memory card.</li><li>• Camera profiles for when [50i] is selected and when [60i] is selected are not compatible.</li><li>• You cannot use a computer to edit saved settings.</li><li>• The file may not be shown properly if the file name is changed on the computer, or the power turned off during generation.</li><li>• A camera profile saved on a camcorder with different model name, or edited on a computer cannot be loaded.</li></ul> Formatting the memory card also deletes saved camera profiles.
<b>ASSIGN BUTTON</b>	ASSIGN1, ASSIGN2, ASSIGN3, ASSIGN4, ASSIGN5, ASSIGN6	Assigns functions to the ASSIGN buttons (p. 62).
<b>CLOCK SET</b>		Sets the date and time (p. 23).
<b>AREA SET</b>		Sets the time difference for when using the camcorder abroad. You can adjust the time difference without stopping the clock.
<b>SUMMERTIME</b>	OFF, ON	Sets whether to use summer time. When set to [ON], the time moves forward 1 hour.
<b>LANGUAGE</b>		Sets the display language.
<b>DATE REC</b>	OFF, ON	Sets whether to record the date and time on the recorded images. <ul style="list-style-type: none"><li>• You can set this item only when the interlace scanning system is selected.</li><li>• When zebra or peaking is activated, the date and time characters are affected by the signal, but are properly recorded on images.</li></ul>
<b>BEEP</b>	OFF, ON	Sets whether to emit a sound when you start/stop recording or when a warning appears, etc.
<b>REC LAMP</b>	ON, OFF	Sets whether to turn on the recording lamp of the camcorder when recording.
<b>REMOTE CONTROL</b>	ON, OFF	Sets whether to use the infrared Wireless Remote Commander (p. 16).

## Menu items (Continued)

OTHERS		
Menu item	Sub-items/Settings	Description
<b>60i/50i SEL</b>		Switches the current frame rate. 60i: For recording 24p, 30p, 60i, or 60p. 50i: For recording 25p, 50i, or 50p.
<b>MEDIA FORMAT</b>	MEMORY CARD A, MEMORY CARD B	Formats a memory card (p. 96).
<b>REPAIR IMAGE DB FILE</b>	MEMORY CARD A, MEMORY CARD B	Repairs the image database file (p. 97).
<b>USB CONNECT</b>		Use this if [USB CONNECT] does not appear after connecting the camcorder to another device with a USB cable.
<b>USB LUN SET</b>	<b>MULTI</b> , SINGLE	Improves compatibility by limiting the functions of the USB connection. Set to [MULTI] under normal conditions. Set to [SINGLE] if you are unable to connect using the [MULTI] setting.
<b>OPERATION TIME</b>		Displays the total hours of operation in 10-hour units.
<b>VERSION DISPLAY</b>		Displays the version of your camcorder. <ul style="list-style-type: none"><li>• Be sure to check for firmware updates.</li><li>• To perform an update, use the AC Adaptor.</li></ul>
<b>INITIALIZE</b>		Resets all settings, including the clock setting to their default values. <ul style="list-style-type: none"><li>• The contents configured in a picture profile are not reset.</li></ul>

## EDIT menu

EDIT		
Menu item	Sub-items/Settings	Description
PROTECT	–	Protects (locks) files (p. 94).
DIVIDE	–	Divides a movie (p. 94).
DELETE	–	Deletes a movie (p. 95).

You can display the [EDIT] menu by pressing the MENU button when the THUMBNAIL or playback screen is displayed.

# Troubleshooting

If you run into any problems using your camcorder, follow the flow chart below.

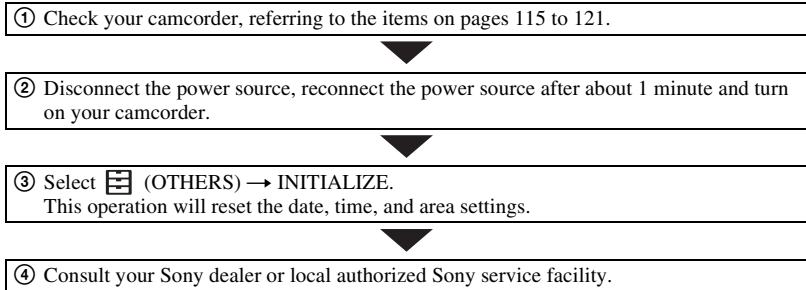

- Power sources/LCD screen/Wireless Remote Commander (p. 115)
- Memory cards (p. 117)
- Recording (p. 117)
- Playback (p. 119)
- Connecting to TV (p. 120)
- Copying/Editing/Connecting to other devices (p. 121)
- Connecting to a computer (p. 121)

## Power sources/LCD screen/Wireless Remote Commander

### The power does not turn on or abruptly turns off.

- Attach a charged battery pack to the camcorder (p. 20).
- Use the AC Adaptor to connect the camcorder to a wall outlet (wall socket) (p. 20).
- The temperature of your camcorder is extremely high. Turn off your camcorder and leave it for a while in a cool place.

### The camcorder does not operate even when the power is set to on.

- Disconnect the power source (battery or AC Adaptor), then reconnect it after about 1 minute.
- Select [OTHERS] (OTHERS) → INITIALIZE.
- The temperature of your camcorder is extremely high. Turn off your camcorder and leave it for a while in a cool place.

### The camcorder gets warm.

- Camera body may get warm with use — this is normal.

### **The remaining battery indicator does not indicate the correct figure.**

- Ambient temperature is too high or too low, or the battery pack has not been charged enough. This is not a malfunction.
  - Fully charge the battery again. If the problem persists, the battery may be worn-out. Replace with a new battery (page 20, 137).
  - The indicated figure may not be correct in certain circumstances. For example, when you open or close the LCD screen, it takes about 1 minute to display the correct remaining battery.
- 

### **The battery pack discharges too quickly.**

- Ambient temperature is too high or too low, or the battery pack has not been charged enough. This is not a malfunction.
  - Fully charge the battery again. If the problem persists, the battery may be worn-out. Replace with a new battery (page 20, 137).
- 

### **The image on the viewfinder is not clear.**

- Move the diopter adjustment dial until the image is clear (p. 25).
- 

### **The viewfinder image is not displayed.**

- Set [VF/LCD PANEL] to [AUTO] (p. 25).
  - Press the ASSIGN6/VF/LCD PANEL button (p. 26).
- 

### **The supplied Wireless Remote Commander does not function.**

- Set [REMOTE CONTROL] to [ON] (p. 113).
  - Remove any obstructions between the Wireless Remote Commander and the remote sensor of the camcorder.
  - Keep strong light sources, such as sunlight or overhead lighting, away from the remote sensor, otherwise the Wireless Remote Commander may not function properly.
  - Change the battery. Insert a fresh battery with the +/- terminals aligned correctly (p. 16).
- 

### **Another video device malfunctions when you use the supplied Wireless Remote Commander.**

- Select a commander mode other than DVD2 for your video device.
  - Cover the sensor of your video device with black paper.
- 

### **The camcorder does not operate normally when a device is connected to the REMOTE jack.**

- The speed in response to commands from the Wireless Remote Commander may be slow.
- The camcorder settings may not be restored if a cable is connected to the REMOTE jack of the camcorder and the device on the other end of the cable is disconnected. Disconnect the cable from the camcorder's REMOTE jack.

## Memory cards

### The camcorder does not operate with the memory card inserted.

- The memory card was formatted on a computer. Format it on this camcorder (p. 96).

---

### The data file name is incorrect, or flashing.

- The file is damaged.
- The file format is not supported on your camcorder (p. 136).

---

### The memory card indicator is flashing.

- An error occurred with the memory card during recording. Stop recording of all memory cards, and repair the database file.

---

### Images on the memory card cannot be deleted.

- You can select no more than 100 images to be deleted on the edit screen.
- The images are protected. Unprotect the images (p. 94).

## Recording

### The recording does not start when you press the START/STOP button.

- The playback screen is displayed. Finish playback operation (p. 67).
- There is no empty space on the memory card. Replace the memory card with a new one or format the memory card (p. 96). Delete unnecessary images (p. 95).
- Total number of movie scenes exceeds the recordable capacity of your camcorder (p. 127). Delete unnecessary images (p. 95).
- The temperature of your camcorder is extremely high. Turn off your camcorder and leave it for a while in a cool place.
- The temperature of your camcorder is extremely low. Turn off your camcorder and leave it for a while in a warm place.
- An error occurred with the memory card during recording. Stop recording of all memory cards, and repair the database file.

---

### The handle zoom does not work.

- Set [HANDLE ZOOM] > [ZOOM OPERATION] to ON (p. 100).

---

### The access lamp remains lit even after recording was stopped.

- Your camcorder is recording the scene you have just shot on the memory card.

---

### The imaging field looks different.

- The imaging field may look different depending on the condition of your camcorder. This is not a malfunction.

### The actual recording time for movies is less than the estimated recording time.

- Depending on the recording conditions, the time available for recording may be shorter, for example when recording a fast moving object, etc. (p. 126).

### The camcorder does not keep the setting changes.

- Some menu items return to the default setting when the power is turned off.
- The [FOCUS MAGNIFIER] setting is not stored.
- The battery pack or AC Adaptor was disconnected while the power was turned on. Before disconnecting the battery pack or AC Adaptor, turn off the power and make sure that the access lamp is turned off.

### There is a time difference between the point when the START/STOP button is pressed and the point that the recording movie actually starts or stops.

- On your camcorder, there may be a slight time difference between the point where you press the START/STOP button and the actual point that recording movie starts/stops. This is not a malfunction.

### Automatic focus does not function.

- In manual mode, set the focus to “AUTO” to enable the automatic focus function (p. 34).
- Adjust the focus manually if the automatic focus does not work properly (p. 34).

### Menu items are grayed out or do not work.

- You cannot select grayed out display items in the current recording/playback situation.
- There are some functions you cannot activate simultaneously. The following list shows examples of unworkable combinations of functions and menu items.

Cannot use (menu disabled)	Situation
[ON/OFF] of [AE SHIFT]	All of iris, gain and shutter speed are set manually.
[ZEBRA], [PEAKING]	[COLOR BAR] is set to [ON].
[ON/OFF] of [MARKER]	[FOCUS MAGNIFIER] is set to [ON].
[TC PRESET]	[TC MAKE] is set to [REGENERATE].
[COLOR BAR]	Movies are being recorded. [FOCUS MAGNIFIER] is set to [ON].

### Iris, gain, shutter speed, or white balance cannot be adjusted manually.

- Press the FULL AUTO button to set auto mode off.

### Tiny spots in white, red, blue, or green appear on the LCD screen.

- This phenomenon appears when using a slow shutter speed (p. 41). This is not a malfunction.

---

**The subjects passing by the frame very fast appear crooked.**

- This is called focal plane phenomenon. This is not a malfunction. Because of the way that the image device (CMOS sensor) reads out image signals, the subjects passing by the frame rapidly might appear crooked depending on the recording conditions.

---

**Horizontal stripes appear on the image.**

- This occurs when recording pictures under a fluorescent lamp, sodium lamp, or mercury lamp. This is not a malfunction. This can be improved by changing the shutter speed (p. 41).

---

**Black bands appear when you record a TV screen or computer screen.**

- Adjust the shutter speed (p. 41).

---

**Fine patterns flicker, diagonal lines look jagged.**

- Adjust [DETAIL] to the negative side (p. 56).

---

**The time code is not recorded in sequence.**

- The time code may not be recorded sequentially if you change the settings of [REC FORMAT].

---

**Image color is not correct.**

- Cancel NIGHTSHOT (p. 49).

---

**The image is not visible because the screen is too bright.**

- Press the FULL AUTO button to set auto mode on.
- Cancel NIGHTSHOT (p. 49).

## Playback

Also refer to “Memory cards” (p. 117).

---

**The desired images cannot be found.****Images cannot be played back.**

- Select the memory card and image quality of the image you want to play back on the THUMBNAIL screen (p. 64).
- Image data cannot be played back if you have modified file names or folders, or have edited the data on a computer. This is not a malfunction.
- Images recorded on other devices may not be played back, or displayed in incorrect size. This is not a malfunction.
- Display the THUMBNAIL screen, select the thumbnail you want to play using the  $\blacktriangle/\blacktriangledown/\blacktriangleleft/\blacktriangleright$  buttons, and press the SET button (p. 66).

### The data file name is incorrect, or flashing.

- The file is damaged.
  - The file format is not supported on your camcorder (p. 136).
  - Only the file name is displayed, if the folder structure does not conform to the universal standard.
- 

### No sound or only a low sound is heard.

- Turn up the volume (p. 66).
- 

### “---” is displayed on the LCD screen.

- Bars will be displayed for the camera data of the movies recorded with [COLOR BAR] set to [ON].
- 

### Multi ch appears on the LCD screen.

- Multi ch appears when you play back movies recorded with 5.1ch surround sound. 5.1ch surround sound is down-mixed to 2ch stereo and played back on your camcorder.
- 

## Connecting to TV

### Neither image nor sound is played back on the TV connected with the HDMI cable.

- Images are not output from the HDMI OUT jack, if copyright protection signals are recorded in the images.
  - Signals are not output from the HDMI OUT jack when the USB jack is connected.
- 

### Neither image nor sound is played back on the TV, projector, or AV amplifier connected with the HDMI cable.

- If you cannot view images or hear sound on the TV, projector, or AV amplifier connected with the HDMI cable, try disconnecting and connecting the HDMI cable, or turn on your camcorder again.
- 

### The image appears distorted on the 4:3 TV.

- This happens when viewing a movie recorded in 16:9 (wide) mode on a 4:3 TV. Select  (REC/OUT SET) → [VIDEO OUT] → [DOWN CONVERT TYPE] and set the appropriate down conversion type (p. 103).
- 

### Black zone appears at top and bottom of a 4:3 TV screen.

- This happens when viewing a movie recorded in the 16:9 (wide) mode on a 4:3 TV. This is not a malfunction.



## Copying/Editing/Connecting to other devices

**Time code and other information appear on the display of the connected device.**

- Set [DISPLAY OUTPUT] to [LCD PANEL] (p. 109).
- 

**Sound cannot be added after recording.**

- You cannot add sound after recording on your camcorder.
- 

**Copy cannot be done correctly using the HDMI cable.**

- You cannot copy movies using the HDMI cable.
- 

## Connecting to a computer

**The computer does not recognize the camcorder.**

- Disconnect the cable from the computer, then connect it again securely.
  - Disconnect the cable from your computer and camcorder. Reboot your computer, and connect your computer and camcorder following the steps in the correct order.
- 

**Movies cannot be viewed or copied to the computer.**

- Disconnect the cable from the computer, then connect it again.
- Software must be installed to copy movies to your computer (p. 20).

# Warning indicators and messages

## Self-diagnosis display/Warning indicators

When an error occurs, a warning indicator appears on the LCD screen or in the viewfinder.

You can fix some problems associated with the symptoms yourself. If the problem persists even after you have tried a couple of times, contact your Sony dealer or local authorized Sony service facility.

---

### C:04:□□

- The battery pack is not an “InfoLITHIUM” battery pack. Use an “InfoLITHIUM” battery pack (p. 137).

---

### C:06:□□

- The battery pack is too hot. Replace the battery pack, or remove the battery pack and put it in a cool place.

---

### C:13:□□

- Remove the memory cards. After installing them again, operate your camcorder.

---

### C:32:□□

- Remove the power source. Reconnect it and operate your camcorder again.

---

### E:□□:□□

- Try steps ② to ④ on page 115.

---

### (Battery level warning)

- The battery pack is nearly used up.
- Depending on the operation, environment, or battery conditions, the indicator may flash, even if around 10% is displayed as the battery remaining figure.

---

### (Warning indicators pertaining to battery pack temperature)

- The battery pack is too hot. Replace the battery pack, or remove the battery pack and put it in a cool place.

---

### (Warning indicator pertaining to the video light)

- The battery level is too low.

---

### (Warning indicators pertaining to memory cards)

#### Slow flashing

- Free space for recording images are running out. For the type of memory cards you can use with your camcorder, see page 27.
- No memory card is inserted (p. 27).

#### Fast flashing

- There is not enough free space for recording images. Delete unnecessary images (p. 95), or format the memory card (p. 96) after you save the images to your computer or another device.
- The image database file may be damaged (p. 97).

---

### (Warning indicators pertaining to memory card formatting)\*

- The memory card is damaged.
- The memory card is not formatted correctly (p. 96).

---

### (Warning indicators pertaining to incompatible memory cards)\*

- Incompatible memory card is inserted (p. 27).

---

### (Warning indicators pertaining to the write-protect of the memory card)\*

- The write-protect switch is set to lock position on the memory card.
  - Access to the memory card was restricted on another device.
- 

\* When [BEEP] is set to [ON] (p. 113), you hear a melody when the warning indicators appear on the LCD screen.

### Description of warning messages

If a warning message is displayed, follow the instructions.

#### Memory cards

**Inconsistencies found in image database file. Do you want to repair the image database file?**

**Inconsistencies found in image database file. Cannot record or play HD movies. Do you want to repair the image database file?**

- You cannot record or play back movies because no movie management information exists. Select [OK] to repair.
- 

**Inconsistencies found in the image database file. Back up and recover. Recover, then import using the included PC software.**

- Inconsistencies occur in the image database file because movie management information is damaged. If you select [OK], the management file is repaired after backing up the movie. The backed up movies cannot be recognized.
- 

If you connect to a computer on which software is installed, you can copy the backed up movies.

However, the loading of all moves is not guaranteed.

---

**Buffer overflow. Writing to the media was not completed in time.**



- You have performed recording and erasing operations repeatedly, or a memory card that has been formatted by other device is used. Back up the data to another device (such as a computer HDD), and then [Empty] the memory card on the camcorder (p. 96).
  - The size of the inserted memory card is not sufficient for copying the movie(s). Use the recommended memory card (p. 27).
- 

**Recovering data. Please wait.**

- Your camcorder tries to recover data automatically if the data writing was not performed properly.
- 

**Cannot recover data.**

- Writing data onto the media of the camcorder has failed. Attempts were made to recover the data, but they were unsuccessful.
- 

  **Reinsert the memory card.**

- Reinsert the memory card a few times. If even then the indicator flashes, the memory card could be damaged. Try with another memory card.
- 

  **Cannot recognize this memory card. Format and use again.**

- Format the memory card using the camcorder (p. 96). Note that if you format the memory card, all the recorded movies and photos are deleted.
-

---

### **This memory card may not be able to record or play movies.**

- Use a memory card recommended for your camcorder (p. 27).

---

### **This memory card may not be able to record or play images correctly.**

- Use a memory card recommended for your camcorder (p. 27).
- Contact your Sony dealer.

---

### **Do not eject the memory card during writing. Data may be damaged.**

- Reinsert the memory card, and follow the instructions on the LCD screen.

### **Other**

---

### **Maximum number of images already selected.**

- You can select only 100 images at one time for:
  - Deleting movies/photos
  - Protecting movies/photos, or releasing the protection

## **Error messages**

The following error messages may appear if trouble occurs during FTP transfer or streaming distribution. Try the solution suggested on the display.

### **No registered access point.**

There are no access points registered. Select  (NETWORK SET) → [Wi-Fi SET] → [ACCESS POINT SET], and register an access point.

### **Cannot find connectable access point. Set the access point setting.**

An access point could not be found. Select  (NETWORK SET) → [Wi-Fi SET] → [ACCESS POINT SET], and check the access point settings.

### **Connection to the access point failed. Please input your password again.**

Could not connect to the access point. Try re-entering the password for the access point.

### **Connection with an access point disconnected. Check the connection condition.**

Connection to the access point was disconnected. Check the access point connection conditions.

### **No response from the access point.**

There was no response from the access point. Check the connection with the access point.

**Failed to acquire an IP address.****Change the IP address setting.**

Could not acquire the IP address.

If connecting to a network via a wireless LAN, select  (NETWORK SET) → [Wi-Fi SET] → [ACCESS POINT SET], and specify the IP address manually.

If connecting to a network via a wired LAN, select  (NETWORK SET) → [WIRED LAN SET], and specify the IP address manually.

**Network error occurred.**

A Wi-Fi communication error occurred.

**Check the USB device connection.**

Check the USB device connection.

**Check the LAN cable connection.**

Could not connect to the network. Check the LAN cable connection.

**Failed to connect to an FTP server.****Check the FTP server settings.**

Check the registered FTP server settings.

**Failed to connect to an FTP server.**

Connection to the FTP server failed because the FTP server could not be found or for other reasons.

**Could not verify the certificate.**

The FTP server certificate is not valid.

**Connection to the FTP server disconnected.**

Connection to the FTP server was disconnected.

**Cannot upload to the FTP server.**

Connection to the FTP server was successful, but a file could not be transferred. Check the transfer destination directory settings and the settings on the FTP server.

**Unable to access the media.**

The memory card could not be loaded.  
The memory card may be damaged.

# Recording time

## Estimated time of recording and playback with each battery pack

Approximate time available when you use a fully charged battery pack.

### Recording time

(Unit: minute)

Battery pack	Continuous recording time	Typical recording time
NP-F770	260	130
NP-F970	400	200

### Notes

- Recording format  
XAVC HD 1080/60i 50Mbps
- Using the internal microphone with [LCD BRIGHT] (p. 109) set to [NORMAL]
- Using a memory card
- Typical recording time shows the time when you repeat recording start/stop, turning on/off, and so on.
- Both recording and playback time will be shorter when you use your camcorder in low temperatures. It is recommended that you use the camcorder from 10 °C to 30 °C (50 °F to 86 °F).
- The recording and playback time will be shorter depending on the conditions under which you use your camcorder.

### Playing time

(Unit: minute)

Battery pack	
NP-F770	410

## Estimated recording time

(Unit: minute)

### XAVC QFHD

4K (QFHD)	2160	
	60Mbps	100Mbps
64GB	100 (100)	65 (65)

4K (QFHD) + PROXY (9M)	2160	
	60Mbps	100Mbps
64GB	85 (85)	55 (55)

### XAVC HD

XAVC	1080			720
	50Mbps	35Mbps	25Mbps	50Mbps
64GB	120 (120)	170 (170)	220 (220)	120 (120)

XAVC + PROXY (9M)	1080			720
	50Mbps	35Mbps	25Mbps	50Mbps
64GB	100 (100)	135 (135)	160 (160)	100 (100)

XAVC + PROXY (3M)	1080			720
	50Mbps	35Mbps	25Mbps	50Mbps
64GB	110 (110)	155 (155)	195 (195)	110 (110)

### MPEG HD 422

MPEG HD 422	1080	720
	50Mbps	50Mbps
64GB	110 (110)	110 (110)

MPEG + PROXY (9M)	1080	720
	50Mbps	50Mbps
64GB	95 (95)	95 (95)

MPEG + PROXY (3M)	1080	720
	50Mbps	50Mbps
64GB	105 (105)	100 (100)

## MPEG HD 420

MPEG HD 420	1080	1080 (1440)	720
	HQ	HQ	HQ
64GB	175 (175)	175 (175)	170 (170)

MPEG + PROXY (9M)	1080	1080 (1440)	720
	HQ	HQ	HQ
64GB	140 (140)	140 (140)	135 (135)

MPEG + PROXY (3M)	1080	1080 (1440)	720
	HQ	HQ	HQ
64GB	160 (160)	160 (160)	155 (155)

## AVCHD

### ■ When [AVCHD AUDIO FORMAT] is set to [LINEAR PCM]

(Unit: minute)

	PS	FX	FH	HQ
16GB	70 (70)	80 (80)	110 (110)	185 (145)
32GB	145 (145)	170 (170)	225 (225)	375 (290)
64GB	290 (290)	340 (340)	450 (450)	750 (590)

### ■ When [AVCHD AUDIO FORMAT] is set to [DOLBY DIGITAL]

(Unit: minute)

	PS	FX	FH	HQ
16GB	75 (75)	90 (90)	120 (120)	215 (165)
32GB	150 (150)	180 (180)	245 (245)	440 (330)
64GB	305 (305)	360 (360)	495 (495)	880 (665)

- When using Sony memory cards.
- The number in ( ) is the minimum recordable time.

### 📌 Note

- The recording time may vary depending on the recording conditions, subjects, and [REC SET] (p. 102).

### 💡 Tips

- The maximum number of scenes that can be recorded is 600 in XAVC HD/QFHD and MPEG HD, and 3,999 in AVCHD.
- The continuous recording time using relay recording is 6 hours for XAVC HD/QFHD and MPEG HD, and 13 hours for AVCHD.
- Your camcorder uses the VBR (Variable Bit Rate) format to automatically adjust image quality to suit the recording scene. This technology causes fluctuations in the recording time of the media. Movies containing quickly moving and complex images are recorded at a higher bit-rate, and this reduces the overall recording time.
- Bit-rate (movie + audio, etc.) and number of pixels of each file format are as follows.

- XAVC QFHD  
100 Mbps 3840×2160  
60 Mbps 3840×2160
- XAVC HD  
50 Mbps 1920×1080  
35 Mbps 1920×1080  
25 Mbps 1920×1080  
50 Mbps 1280×720
- MPEG HD 422  
50Mbps, 1920×1080  
50Mbps, 1280×720

## Recording time (Continued)

– MPEG HD 420

HQ: 35Mbps (max) 1920×1080

HQ: 35Mbps (max) 1440×1080

HQ: 35Mbps (max) 1280×720

– AVCHD

PS: max 28Mbps 1920×1080

FX: max 24Mbps 1920×1080, 1280×720

FH: approx. 17Mbps (avg) 1920×1080,

1280×720

HQ: approx. 9Mbps (avg) 1280×720



# Function limitations when recording

For details about limitation when streaming is ON, see page 88.

## Limitations for each file format

Yes: Supported, No: Not supported

Functions	XAVC QFHD	XAVC HD	MPEG HD	AVCHD
RELAY REC (p. 31)	Yes	Yes	Yes	Yes
SIMULTANEOUS REC (p. 32)	Yes	Yes	Yes	Yes
FACE DETECTION (p. 35)	Yes* <sup>1</sup>	Yes	Yes	Yes
PROXY REC MODE (p. 39)	Yes* <sup>2</sup>	Yes	Yes	No
RELAY REC + PROXY REC MODE	Yes (60 Mbps only)	Yes	Yes	No
SIMULTANEOUS REC + PROXY REC MODE	Yes (60 Mbps only)	Yes	Yes	No
Slow-motion at high frame rate (p. 58).	No	Yes	No	No
S&Q MOTION (p. 58)	No	Yes	Yes	Yes
STREAMING (p. 87)	Yes (60 Mbps only)	Yes	Yes	Yes
COLOR BAR (p. 102)	No	Yes (when proxy recording is OFF)	Yes (when proxy recording is OFF)	Yes
DATE REC (p. 113)	No	Yes (Interlaced recording)	Yes (Interlaced recording)	Yes (Interlaced recording)

\*<sup>1</sup> When streaming and proxy recording are OFF. When the output during QFHD recording is the viewfinder/LCD screen.

\*<sup>2</sup> When the output during QFHD recording is the viewfinder/LCD screen. When SIMULTANEOUS REC/RELAY REC is OFF at 100Mbps.

### Slow & Quick Motion and High Frame Rate recording limitations

Yes: Supported, No: Not supported

Functions	Slow & Quick Motion	Slow-motion at high frame rate (XAVC HD only)
RELAY REC (p. 31)	No	No
SIMULTANEOUS REC (p. 32)	No	No
FACE DETECTION (p. 35)	No	No
PROXY REC MODE (p. 39)	No	No
Audio recording	No	No
Full auto mode (p. 48)	No	No
Remote control from smartphone (p. 78)	No	No
STREAMING (p. 87)	No	No
D. EXTENDER (p. 99)	Yes	No
DIGITAL ZOOM/CLEAR IMAGE ZOOM (p. 100)	Yes	No
STEADYSHOT (p. 100)	Yes	[ACTIVE] not available
AUTO BACK LIGHT (p. 101)	Yes	No
COLOR BAR (p. 102)	No	No
DATE REC (p. 113)	No	No

The following limitations also apply when shooting in High Frame Rate.

- Black gamma is fixed to 0.
- Shutter speed limitations apply (minimum value of 1/120 (when [60i] is selected), 1/100 (when [50i] is selected)).
- The HDMI output is fixed to 60p or 60i (when [60i] is selected), or 50p or 50i (when [50i] is selected).

# Proxy recording supported formats

## Notes

- Proxy recording is not supported when the following three are selected at the same time.
  - Recording mode: 4K (XAVC QFHD)
  - Recording format bit rate: 100Mbps
  - Simultaneous/relay recording: ON
- Proxy recording is not supported when the output during XAVC QFHD recording is set to external output.
- Proxy recording is not supported for AVCHD.

Original file		Proxy file					
Image size	Frame rate (fps)	1280×720			640×360		
		60(50)p	30(25)p	24p	60(50)p	30(25)p	24p
		Bit rate (Mbps)					
3840×2160	30(25)p	100	Yes		Yes		
		60	Yes		Yes		
	24p	100		Yes			Yes
		60		Yes			Yes
1920×1080	60(50)p	50	Yes		Yes		
		35	Yes		Yes		
	60(50)i	50		Yes			Yes
		35		Yes			Yes
		25		Yes			Yes
	30(25)p	50		Yes			Yes
		35		Yes			Yes
	24p	50			Yes		Yes
		35			Yes		Yes
	1280×720	60(50)p	50	Yes		Yes	
1440×1080	60(50)i	HQ		Yes		Yes	

# Streaming supported formats

Original file (XAVC)		Streaming data				
Image size		1280×720			640×360	
Frame rate (fps)		30(25)p	24p	60(50)p	30(25)p	24p
Bit rate (Mbps)		3	3	2	1	1
3840×2160	30(25)p	60	Yes		Yes	
	24p	60		Yes		Yes
1920×1080	60(50)p	50		Yes		
		35			Yes	
	60(50)i	50	Yes			Yes
		35	Yes			Yes
		25	Yes			Yes
	30(25)p	50	Yes			Yes
		35	Yes			Yes
24p	50		Yes			Yes
	35		Yes			Yes
1280×720	60(50)p	50			Yes	

Original file (AVCHD)		Streaming data					
Image size		1280×720			640×360		
Frame rate (fps)		30(25)p	24p	60(50)p	30(25)p	24p	
Bit rate (Mbps)		3	3	2	1	1	
1920×1080	60(50)p	PS					
	60(50)i	FX	Yes		Yes		
		FH	Yes			Yes	
	30(25)p	FX	Yes			Yes	
		FH	Yes			Yes	
	24p	FX		Yes			Yes
		FH		Yes			Yes
1280×720	60(50)p	FX					
		FH					
		HQ					

Original file (MPEG HD 422)			Streaming data				
Image size			1280×720		640×360		
	Frame rate (fps)		30(25)p	24p	60(50)p	30(25)p	24p
	Bit rate (Mbps)		3	3	2	1	1
1920×1080	60(50)i	50	Yes			Yes	
	30(25)p	50	Yes			Yes	
	24p	50		Yes			Yes
1280×720	60(50)p	50			Yes		

Original file (MPEG HD 420)			Streaming data				
Image size			1280×720		640×360		
	Frame rate (fps)		30(25)p	24p	60(50)p	30(25)p	24p
	Bit rate (Mbps)		3	3	2	1	1
1920×1080	60(50)i	HQ	Yes			Yes	
	30(25)p	HQ	Yes			Yes	
	24p	HQ		Yes			Yes
1280×720	60(50)p	HQ			Yes		
1440×1080	60(50)i	HQ	Yes			Yes	

# Using your camcorder abroad

## Power supply

You can use your camcorder in any country/region using the AC Adaptor supplied with your camcorder within the AC 100V to 240V, 50Hz/60Hz range.

## Viewing on TV

The following shows which countries and regions use 60i and 50i models.

Countries and regions for [60i] use  
Bahama Islands, Barbados, Bermuda, Bolivia, Canada, Central America, Chile, Colombia, Costa Rica, Cuba, Dominican Republic, Ecuador, El Salvador, Guam, Guatemala, Guyana, Haiti, Honduras, Jamaica, Japan, Korea, Mexico, Micronesia, Myanmar, Nicaragua, Panama, Peru, the Philippines, Puerto Rico, Saint Lucia, Samoa, Surinam, Taiwan, Trinidad and Tobago, the U.S.A., Venezuela, etc.

Countries and regions for [50i] use  
Argentina, Australia, Austria, Belgium, Brazil, Bulgaria, China, Croatia, Czech Republic, Denmark, Finland, France, French Guiana, Germany, Greece, Hong Kong, Hungary, Indonesia, Iran, Iraq, Italy, Kuwait, Malaysia, Monaco, the Netherlands New Zealand, Norway, Paraguay, Poland, Portugal, Romania, Russia, Singapore, Slovak Republic, Spain, Sweden, Switzerland, Thailand, Turkey, Ukraine, United Kingdom, Uruguay, Vietnam, etc.

## Simple setting of the clock by time difference

When you are abroad, you can easily adjust the clock to the local time by setting the time difference. Select [AREA SET], then set the time difference (p. 113).

# File/folder structure on the recording media

The file/folder structure is shown below. You do not usually need to acknowledge the file/folder structure, when recording/playing back movies and still images on the camcorder.

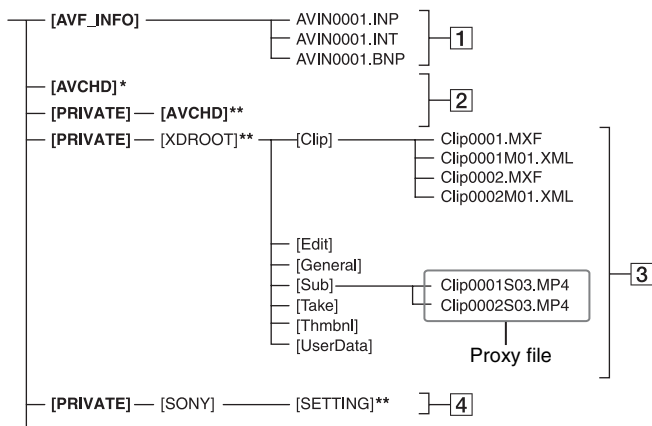

\* “Memory Stick PRO Duo”

\*\* SD memory card, SDHC memory card, SDXC memory card

## 1 Image management files

When you delete the files, you cannot record/play back the images correctly.

The files are defaulted as hidden files and not usually displayed.

## 2 AVCHD movie management information folder

This folder contains recording data of AVCHD movie files.

## 3 XAVC/MPEG movie management information folder

This folder contains recording data of XAVC/MPEG movie files.

The file numbers go up automatically.

## 4 Camera profiles

Stores camera profile data.

- When you delete image files, follow the steps on page 95. Do not delete the image files on the camcorder directly from the computer.
  - Do not format the recording media in the camcorder using a computer. The camcorder may not operate correctly.
  - Do not copy the files on the recording media from a computer. Operation is not guaranteed, if you perform this operation.
  - Use application software to import data from a memory card to a computer (p. 20).
- Do not modify the files or folders on the camcorder from the computer. Doing so might damage image files, or prevent image files from being played back.
  - Sony accepts no responsibility for the results of operation using data copied from a PC to a memory card.

# Maintenance and precautions

## About the XAVC format

### Recording and playback on your camcorder

Your camcorder can record 4K (QFHD) and HD (high definition) based on the XAVC format.

This uses a Long-GOP video compression format for recording.

Video\*: MPEG-4AVC/H.264

When [60i] is selected:

3840×2160/30p, 3840×2160/24p,  
1920×1080/60p, 1920×1080/60i,  
1920×1080/30p, 1920×1080/24p,  
1280×720/60p

When [50i] is selected:

3840×2160/25p, 1920×1080/50p,  
1920×1080/50i, 1920×1080/25p,  
1280×720/50p

Audio: LPCM 2 ch

Recording media: Memory card

\* The camcorder is not able to play back data that is recorded in XAVC format using settings other than those described above.

## About the MPEG format

### Recording and playback on your camcorder

Based on the MPEG format, your camcorder records with the HD (high definition) image quality.

This uses a Long-GOP video compression format for recording.

Video\*: MPEG-2 MP@HL

When [60i] is selected:

1920×1080/60i, 1920×1080/30p,  
1920×1080/24p, 1440×1080/60i,  
1280×720/60p

When [50i] is selected:

1920×1080/50i, 1920×1080/25p,  
1440×1080/50i, 1280×720/50p

Video\*: MPEG-2 422P@HL

When [60i] is selected:

1920×1080/60i, 1920×1080/30p,

1920×1080/24p, 1280×720/60p

When [50i] is selected:

1920×1080/50i, 1920×1080/25p,  
1280×720/50p

Audio: LPCM 2 ch

Recording media: Memory card

\* The camcorder is not able to play back data that is recorded in MPEG format using settings other than those described above.

## About the AVCHD format

### Recording and playback on the camcorder

Based on the AVCHD format, your camcorder records with the HD (high definition) image quality.

Video\*: MPEG-4AVC/H.264

When [60i] is selected:

1920×1080/60p, 1920×1080/60i,  
1920×1080/30p, 1920×1080/24p,  
1280×720/60p

When [50i] is selected:

1920×1080/50p, 1920×1080/50i,  
1920×1080/25p, 1280×720/50p

Audio: Dolby Digital 2ch, LPCM 2 ch

Recording media: memory card (sold separately)

\* Data recorded in AVCHD format other than the above mentioned cannot be played back on your camcorder.

• Because the AVCHD format uses a data compression system, images may be distorted in scenes where the image, angle, or brightness changes drastically. This is not a malfunction.

## About memory cards

• A memory card formatted on a computer does not have guaranteed compatibility with your camcorder.

• Data read/write speed may vary depending on the combination of the memory card and memory card compliant product you use.

• Damaged or lost image data will not be compensated for, and may occur in the following cases:



– If you eject the memory card, turn the power off on your camcorder, or remove the battery pack for replacement while your camcorder is reading or writing image files on the memory card (while the access lamp is lit or flashing).

– If you use the memory card near electric fields, magnetic fields, or other sources of electromagnetic noise.

- It is recommended to make a back-up of important data on the hard disk of a computer.
- Do not attach a label or the like on memory card.
- Do not touch, or allow metallic objects to come into contact with the terminals.
- Do not bend, drop or apply strong force to the memory card.
- Do not disassemble or modify the memory card.
- Do not let the memory card get wet.
- Be careful to keep memory card out of the reach of small children. There is danger that a child might swallow it.
- Do not insert anything other than the compliant size of memory card into the memory card slot. Doing so may cause a malfunction.
- Do not use or keep the memory card in the following locations:
  - Places subject to extremely high temperature, such as a car parked outside in the summer
  - Places under direct sunlight
  - Places with extremely high humidity or subject to corrosive gases

## On image data compatibility

- Image data files recorded on a memory card by your camcorder conform to the “Design rule for Camera File system” universal standard established by the JEITA (Japan Electronics and Information Technology Industries Association).
- If you cannot use the memory card that has been used with another device, format it with your camcorder using the procedure on page 96. Note that formatting erases all information on the memory card.
- You may not be able to play back images with your camcorder:
  - When playing back image data modified on your computer.
  - When playing back image data recorded with other devices.

## About “Memory Stick” media

Types of “Memory Stick” media	Recording/ Playback
“Memory Stick Duo” (with MagicGate)	–
“Memory Stick PRO Duo” (Mark2)	Yes
“Memory Stick PRO-HG Duo”	Yes

- This product supports parallel data transfer. However, the transfer speed may differ, depending on the type of media you use.
- This product cannot record or play data that uses “MagicGate” technology. “MagicGate” is a copyright protection technology that records and transfers the contents in an encrypted format.

## About the “InfoLITHIUM” battery pack

Your camcorder operates only with an “InfoLITHIUM” L series battery pack of a large capacity, such as the NP-F770 and NP-F970 (sold separately).

“InfoLITHIUM” L series battery packs have the  mark.

## What is an “InfoLITHIUM” battery pack?

An “InfoLITHIUM” battery pack is a lithium-ion battery pack that has functions for communicating information related to operating conditions between your camcorder and a supplied AC Adaptor. The “InfoLITHIUM” battery pack displays the remaining battery time in % according to the operating situations of your camcorder.

## To use the battery pack effectively





- Battery pack performance decreases when the ambient temperature is 10 °C (50 °F) or below, and the length of time you can use the battery pack becomes shorter. In that case, do one of the following to use the battery pack for a longer time.

## Maintenance and precautions (Continued)

- Put the battery pack in a pocket to warm it up, and install it in your camcorder right before you start taking shots.
- Make sure to turn off the camcorder when you are not recording or playing back. The battery pack is also consumed when your camcorder is in recording standby or playback pause.
- Have spare battery packs ready for 2 or 3 times the expected recording time, and make trial recordings before making the actual recording.
- Do not expose the battery pack to water. The battery pack is not water resistant.

### About the remaining battery indicator

- Check the level with the following indicators and % displayed on the LCD screen.

Battery remaining indicator	%
	81% to 100%
	51% to 80%
	21% to 50%
	1% to 20%
	–

- The displayed level may not be correct under certain circumstances.
- When the power goes off even though the remaining battery percent indicator indicates that the battery pack has enough power to operate, charge the battery pack fully again. Remaining battery percent will be indicated correctly. Note, however, that the battery indication will not be restored if it is used in high temperatures for a long time, or if left in a fully charged state, or when the battery pack is frequently used. Use the remaining battery percent indication as a rough guide only.

### About storage of the battery pack

- If the battery pack is not used for a long time, fully charge the battery pack and use it up on your camcorder once a year to maintain proper function. To store the battery pack, remove it from your camcorder and put it in a dry, cool place.
- To discharge the battery pack on your camcorder completely, leave your camcorder in recording standby until the power goes off.

### About battery life

- Battery capacity decreases over time and through repeated use. If decreased usage time between charges becomes significant, it is probably time to replace it with a new one.
- Each battery's life is governed by storage, operating and environmental conditions.

### About charging the battery pack

- Use the AC Adaptor (supplied) to charge the designated batteries only. If you charge other types of batteries, those batteries may leak, heat up, burst, or give an electric shock, resulting in burns or injury.
- Remove the charged battery from the AC Adaptor.
- The CHG lamp of the supplied AC Adaptor flashes in 2 patterns as follows:  
Fast-flashing...Turns on and off rapidly at about 0.15-second intervals.  
Slow-flashing...Turns on and off alternately for about 1.5 seconds, and turns off completely for about 1.5 seconds. The lamp repeats this sequence.
- If the CHG lamp is fast-flashing, remove the battery that is being charged, and then re-attach the same battery again firmly. If the CHG lamp continues fast-flashing, the cause could be that the battery is damaged, or the battery is not a designated type. Check the battery to confirm whether it is a designated type or not. If it is a designated type, remove the battery first, and then attach a brand-new battery or another known-to-be-good battery to see if the AC Adaptor is working correctly. If the AC Adaptor is working correctly, the cause could be that the battery is damaged.
- If the CHG lamp is slow-flashing, the AC Adaptor is in standby mode and charging is suspended. When the ambient temperature is out of the appropriate temperature range for charging, the AC Adaptor suspends charging automatically and enters standby mode. When the ambient temperature returns to an appropriate temperature, the AC Adaptor restarts charging and the CHG lamp lights up. We recommend charging the battery pack in an ambient temperature of from 10 °C to 30 °C (50 °F to 86 °F).

## About handling of your camcorder

### On use and care

- Do not use or store the camcorder and accessories in the following locations.
  - Anywhere extremely hot or cold.  
Never leave them exposed to temperatures above 60 °C (140 °F), such as under direct sunlight, near heaters or in a car parked in the sun. They may malfunction or become deformed.
  - Near strong magnetic fields or mechanical vibration.  
The camcorder may malfunction.
  - Near strong radio waves or radiation.  
The camcorder may not be able to record properly.
  - Near AM receivers and video equipment.  
Noise may occur.
  - On a sandy beach or anywhere dusty.  
If sand or dust gets in your camcorder, the camcorder may malfunction. Sometimes this malfunction cannot be repaired.
  - Near windows or outdoors, where the LCD screen, the viewfinder, or the lens may be exposed to direct sunlight.  
This damages the inside of the viewfinder or the LCD screen.
  - Anywhere very humid.
- Operate your camcorder on 7.2 V (battery pack) or 8.4 V DC (AC Adaptor).
- For DC or AC operation, use the accessories recommended in these operating instructions.
- Do not let your camcorder get wet, for example, from rain or sea water. If your camcorder gets wet, it may malfunction. Sometimes this malfunction cannot be repaired.
- If any solid object or liquid gets inside the casing, unplug your camcorder and have it checked by a Sony dealer before operating it any further.
- Avoid rough handling, disassembling, modifying, physical shock, or impact such as hammering, dropping or stepping on the product. Be particularly careful of the lens.
- Do not use a deformed or damaged battery pack.
- Keep the ON/STANDBY switch set to the standby position when you are not using your camcorder.

- Do not wrap your camcorder with a towel, for example, and operate it. Doing so might cause heat to build up inside.
- When disconnecting the power cord (mains lead), pull it by the plug and not the lead.
- Do not damage the power cord (mains lead) such as by placing anything heavy on it.
- Keep metal contacts clean.
- Keep the Wireless Remote Commander and button-type battery out of children's reach. If the battery is accidentally swallowed, consult a doctor immediately.
- If the battery electrolytic liquid has leaked,
  - consult your local authorized Sony service facility.
  - wash off any liquid that may have contacted your skin.
  - if any liquid gets in your eyes, wash with plenty of water and consult a doctor.

### ■ When not using your camcorder for a long time

- Turn on the camcorder and record and play back images about once a month to keep it in an optimum state for a long time.
- Use up the battery pack completely before storing it.

### Moisture condensation

If your camcorder is brought directly from a cold place to a warm place, moisture may condense inside your camcorder and cause a malfunction of your camcorder.

#### ■ If moisture condensation has occurred

Leave your camcorder for about 1 hour without turning it on.

#### ■ Note on moisture condensation

Moisture may condense when you bring your camcorder from a cold place into a warm place (or vice versa) or when you use your camcorder in a humid place as shown below.

- When you bring your camcorder from a ski slope into a place warmed up by a heating device.
- When you bring your camcorder from an air conditioned car or room into a hot place outside.
- When you use your camcorder after a squall or a shower.
- When you use your camcorder in a hot and humid place.

## Maintenance and precautions (Continued)

### ■ How to avoid moisture condensation

When you bring your camcorder from a cold place into a warm place, put your camcorder in a plastic bag and seal it tightly. Remove the bag when the air temperature inside the plastic bag has reached the ambient temperature (after about 1 hour).

### LCD screen

- Do not exert excessive pressure on the LCD screen, as it may cause damage.
- If your camcorder is used in a cold place, a residual image may appear on the LCD screen. This is not a malfunction.
- While using your camcorder, the back of the LCD screen may heat up. This is not a malfunction.

### ■ To clean the LCD screen

The LCD screen is covered with a coating. The coating may be peeled off by scratching or rubbing. Maintain the LCD screen as follows.

- Wipe fingerprints or hand cream off the LCD screen as soon as possible, as they may cause the coating to peel off.
- If you rub the LCD screen hard, even with a tissue, the coating may be damaged.
- Before wiping the LCD screen, blow dust or sand off with a dust blower, etc.
- Wipe dirt off the LCD screen with a clean, soft cloth, such as an eye glass cleaning cloth, etc.

### Casing

- If the casing is soiled, clean the camcorder body with a soft cloth lightly moistened with water, and then wipe the casing with a dry soft cloth.
- Avoid the following to prevent damage to the finish.
  - Using chemicals such as thinner, benzine, alcohol, chemical cloths, repellent, insecticide and sunscreen.
  - Handling with above substances on your hands.
  - Leaving the casing in contact with rubber or vinyl objects for a long period of time.

### Care and storage of the lens

- Wipe the surface of the lens clean with a soft cloth in the following instances: when there are fingerprints on the lens surface, in hot or humid locations, and when the lens is exposed to salty air such as at the seaside.

- Store in a well-ventilated location subject to little dirt or dust.
- To prevent mold, periodically clean the lens as described above.

### Charging the pre-installed rechargeable battery

Your camcorder has a pre-installed rechargeable battery to retain the date, time, and other settings even when the ON/STANDBY switch is set to STANDBY. The pre-installed rechargeable battery is always charged while your camcorder is connected to the wall outlet (wall socket) via the AC Adaptor or while the battery pack is attached. The rechargeable battery will be fully discharged in about **3 months** if you do not use your camcorder at all, with the AC Adaptor not connected or battery pack not attached. Use your camcorder after charging the pre-installed rechargeable battery.

However, even if the pre-installed rechargeable battery is not charged, the camcorder operation will not be affected as long as you are not recording the date.

### ■ Charging procedure

Connect your camcorder to a wall outlet (wall socket) using the supplied AC Adaptor, and leave it with the power turned off for more than 24 hours.

### Note on disposal/transfer of the memory card

Even if you delete data in the memory card or format the memory card on your camcorder or a computer, you may not delete data from the memory card completely. When you give the memory card to somebody, it is recommended that you delete data completely using data deletion software on a computer. Also, when you dispose of the memory card, it is recommended that you destroy the actual body of the memory card. Operation is not guaranteed when using a card adaptor.

## **To prevent electromagnetic interference from portable communications and other wireless devices**

The use of portable telephones and other communications devices near this camera can result in malfunctions and interference with audio and video signals. It is recommended that the portable communications devices near this camera be powered off.

# Specifications

## General

### Power requirements

- 8.4 V DC (using AC Adaptor)
- 7.2 V DC (using battery pack)

### Power consumption

- While recording XAVC HD, using viewfinder:
  - Approx. 6.3 W
- While recording XAVC HD, using LCD screen:
  - Approx. 6.6 W

### Operating temperature

- 0 °C to 40 °C (32 °F to 104 °F)

### Storage temperature

- 20 °C to +60 °C (-4 °F to +140 °F)

### Dimensions

- (Camcorder body, including projecting parts)
  - 171.3 mm × 187.8 mm × 371.3 mm
  - (6 3/4 in. × 7 1/2 in. × 14 5/8 in.)
- (Including lens hood, large eyecup, and battery (NP-F770). Excluding the grip belt.) (width / height / depth)

### Mass

- Approx. 1.9 kg (4 lb. 3 oz.) (body only)
- Approx. 2.3 kg (5 lb.) (Including lens hood, eyecup, and battery (NP-F770))

## System

### Signal format

- When [60i] is selected:
  - NTSC color, EIA standards
  - HDTV 1080/60i, 1080/60p, 720/60p
- When [50i] is selected:
  - PAL color, CCIR standards
  - HDTV 1080/50i, 1080/50p, 720/50p

### Video recording system

- XAVC QFHD: MPEG-4 AVC/H.264 4:2:0 Long profile
- XAVC HD: MPEG-4 AVC/H.264 4:2:2 Long profile
- XAVC Proxy: MPEG-4 AVC/H.264 4:2:0 Long profile

MPEG HD422: MPEG-2 422P@HL 4:2:2 Long profile

MPEG HD420: MPEG-2 MP@HL 4:2:0 Long profile

MPEG HD Proxy: MPEG-4 AVC/H.264 4:2:0 Long profile

AVCHD: MPEG-4 AVC/H.264 AVCHD 2.0 format compatible

### Audio recording format

- XAVC QFHD: Linear PCM 2-ch, 24-bit, 48 kHz
- XAVC HD: Linear PCM 2-ch, 24-bit, 48 kHz
- XAVC Proxy: AAC-LC 2-ch, 16-bit, 48 kHz
- MPEG HD422: Linear PCM 2-ch, 24-bit, 48 kHz
- MPEG HD420: Linear PCM 2-ch, 16-bit, 48 kHz
- MPEG HD Proxy: AAC-LC 2-ch, 16-bit, 48 kHz
- AVCHD: Linear PCM 2ch, 16-bit, 48 kHz/Dolby Digital 2ch, 16-bit, 48 kHz

### Recording media

Memory Stick PRO Duo™ and SD card

## Camera

### Imaging element

- 1.0-type Exmor RS CMOS sensor
- Total picture elements: Approx. 20,900,000 pixels
- Effective picture elements: Approx. 14,200,000 pixels

### Zoom ratio

- 4K:
  - 12× (optical zoom), 18× (clear image zoom), 192× (digital zoom)

HD:

12× (optical zoom), 24× (clear image zoom), 192× (digital zoom)

### White balance

Preset (Indoor: 3200K, Outdoor: 5600K ± 7 steps, Color temperature set range: 2300K to 15000K), One-push A, B, Auto selectable

### Minimum illumination

When [60i] is selected:  
1.7 lux (LOW LUX mode: On)  
When [50i] is selected:  
1.7 lux (LOW LUX mode: On)

### Shutter speed

When [60i] is selected:  
1/8 sec. to 1/10,000 sec. (1/6 sec. to 1/10,000 sec. when shooting 24p)  
When [50i] is selected:  
1/6 sec. to 1/10,000 sec.

### Slow & Quick Motion

XAVC HD/MPEG HD/AVCHD  
Frame rate selectable

### High Frame Rate

XAVC HD  
When [60i] is selected: 120 fps  
When [50i] is selected: 100 fps

### Gain

-3, 0, 3, 6, 9, 12, 15, 18, 21, 24, 27, 30,  
33 dB, AGC

### Gamma curve

Selectable

### Built-in ND filter

OFF: CLEAR  
1:  $\frac{1}{4}$ ND  
2:  $\frac{1}{16}$ ND  
3:  $\frac{1}{64}$ ND

### Lens

#### Lens mount

Fixed

#### Zoom ratio

12× (optical), servo

#### Focal Length

f = 9.3 mm to 111.6 mm

(equivalent to f = 29.0 mm to 348.0 mm on 35 mm lens)

### Iris

F2.8 to F4.5 (auto/manual selectable)

### Focus

Auto/manual selectable  
10 mm to ∞ (Wide)  
1000 mm to ∞ (Tele)

### Image stabilizer

On/Off selectable, shift lens

### Filter diameter

M62 mm

### Input/output

#### Video output

Multi/micro USB jack (1), Pin jack (1)  
Composite (1.0 Vp-p, 75 ohms)

#### Audio output

Multi/micro USB jack (1), Pin jack (monaural) (1)

#### SDI signal output

BNC type (1)

#### HDMI signal output

Type A (1)

#### USB

Multi/micro USB jack (1)

#### Ⓜ (Headphones) output

Stereo mini jack (φ3.5 mm) (1)

#### Speaker

Monaural

#### Audio input

XLR-type 3-pin (female) (2), line/mic/  
mic +48 V selectable

#### DC input

DC jack

#### REMOTE jack

Stereo minimini jack (φ2.5 mm) (1)

### Screen

#### LCD screen

8.8 cm (3.5 type)  
Approx. 1.56M dots

## Specifications (Continued)

### Viewfinder

1.0 cm (0.39-type) OLED  
Approx. 1.44M dots

### Internal microphone

Omni-directional stereo electret  
condenser microphone

### Wireless LAN

#### Supported standards

IEEE 802.11b/g/n

#### Frequency band

2.4 GHz band

#### Security

WEP/WPA-PSK/WPA2-PSK

#### NFC

NFC Forum Type 3 Tag compliant

#### Streaming

MPEG-2 TS/UDP

#### FTP

FTP, FTPS

### AC Adaptor (AC-L100C)

#### Power requirements

100 V to 240 V AC, 50 Hz/60 Hz

#### Power consumption

18 W

#### Output voltage

8.4 V DC\*

#### Operating temperature

0 °C to 40 °C (32 °F to 104 °F)

#### Storage temperature

-20 °C to +60 °C (-4 °F to +140 °F)

#### Dimensions

Approx. 48 mm × 29 mm × 81 mm  
(1 15/16 in. × 1 3/16 in. × 3 1/4 in.)  
(width / height / depth) excluding  
projecting parts

#### Mass (body only)

Approx. 180 g (6.3 oz.)

\* Refer to the labels for other specifications.

### Rechargeable battery pack (NP-F770)

#### Maximum output voltage

8.4 V DC

#### Output voltage

7.2 V DC

#### Maximum charging voltage

8.4 V DC

#### Maximum charging current

3.0 A

#### Capacity

Typical: 31.7 Wh (4,400 mAh)

Minimum: 30.0 Wh (4,200 mAh)

#### Type

Li-ion

### DC battery charger (BC-L1)

#### Input rating

8.4 V DC

#### Output rating

8.4 V DC, 1.7 A

#### Operating temperature

0 °C to 40 °C (32 °F to 104 °F)

#### Storage temperature

-20 °C to +60 °C (-4 °F to +140 °F)

#### Dimensions

Approx. 72 mm × 20.5 mm × 96.5 mm  
(2 7/8 in. × 13/16 in. × 3 7/8 in.)  
(width / height / depth)

#### Mass

Approx. 60 g (2.1 oz)



# Index

## A

AC Adaptor.....19, 20  
Access point.....82  
Accessory shoe.....22  
AE SHIFT.....118  
AGC LIMIT.....99  
AIRPLANE MODE.....112  
AREA SET.....113  
ASPECT.....108  
ASSIGN BUTTON.....113  
ASSIGN buttons.....62  
AUDIO LEVEL dial.....45  
AUDIO LEVEL  
DISPLAY.....109  
AUDIO LIMIT.....104  
AUDIO OUT jack.....12  
AUDIO SET menu.....104  
AUTO BACK LIGHT.....101  
AUTO/MAN switch.....45  
Auto mode.....48  
AUTO MODE SET.....101  
AVCHD.....37, 136  
AVCHD AUDIO  
FORMAT.....104

## B

BATT RELEASE button.....21  
Battery.....20  
BEEP.....113  
BLACK GAMMA.....52  
BLACK LEVEL.....52  
Button-type lithium  
battery.....16

## C

CAMERA DATA  
DISPLAY.....108  
CAMERA PROFILE.....113  
CAMERA SET menu.....99  
CENTER.....108  
Charging time.....21

CHG lamp.....20  
CH-1/CH-2 switches.....45  
CLOCK SET.....23  
COLOR BAR.....118  
COLOR DEPTH.....54  
COLOR MODE.....53  
COLOR PHASE.....54  
Connect  
tv or monitor.....70  
Content Browser Mobile.....78  
CONVERSION LENS.....100  
CTRL  
W/SMARTPHONE.....111

## D

DATA CODE.....68, 109  
Date and time.....18, 23, 24  
DATE REC.....113  
DC IN jack.....21  
DELETE.....95  
DETAIL.....56  
D. EXTENDER.....99  
DISPLAY button.....68  
DISPLAY OUTPUT.....109  
DISPLAY SET menu.....107  
DIVIDE.....94  
DOWN CONVERT  
TYPE.....103  
Drop frame.....110

## E

EDIT menu.....114  
Error messages.....124

## F

FACE DETECTION.....35  
File format.....37  
limitations.....129  
Focus.....34  
FOCUS AUTO/  
MAN button.....34

FOCUS DISPLAY.....109  
FOCUS MAG button.....34  
FOCUS MAG RATIO.....108  
Focus Magnifier.....34  
Focus ring.....34  
Format media.....96  
FTP.....89  
FTP TRANSFER.....111  
FULL AUTO button.....48  
Function limitations.....129

## G

Gain.....41  
GAIN button.....41  
GAMMA.....52  
Getting started.....19  
GUIDEFRAAME.....108

## H

Handle record button.....32  
Handle zoom.....33  
Handle zoom lever.....33  
HDMI OUT jack.....12  
HEADPHONE OUT.....104  
Headphones jack.....15  
Headphones output.....47  
HFR.....58  
High Frame Rate.....58  
limitations.....130  
HISTOGRAM.....107

## I



Image database file.....97  
INDOOR.....43  
“InfoLITHIUM”  
battery pack.....137  
INITIALIZE.....114  
INPUT1/2 jacks.....45  
INPUT1/2 switches.....45  
INT MIC SET.....104  
Iris.....40

## Index (Continued)

- IRIS AUTO/MAN button..... 40  
Iris ring ..... 40
- K**  
KNEE ..... 53
- L**  
LANGUAGE..... 113  
Large eyecup ..... 25  
LAST SCENE button ..... 61  
Last Scene Review ..... 61  
LCD BRIGHT ..... 109  
LCD screen..... 24  
Lens ..... 11, 140  
Lens cover ..... 11  
LOW LUX..... 49
- M**  
MANU WB TEMP..... 43  
Manual lever..... 41  
MARKER ..... 118  
Maximum recording time... 126  
MEDIA FORMAT ..... 96  
Memory card  
    file/folder structure..... 135  
    formatting ..... 96  
    inserting/ejecting ..... 27  
    notes ..... 136  
    supported memory cards ..... 27  
“Memory Stick” media..... 137  
Menu..... 98  
    AUDIO SET..... 104  
    CAMERA SET..... 99  
    DISPLAY SET..... 107  
    EDIT..... 114  
    items ..... 99  
    NETWORK SET..... 111  
    OTHERS ..... 113  
    REC/OUT SET..... 102  
    TC/UB SET..... 110
- MENU button ..... 98  
MIC+48V..... 45  
Microphone  
    attaching ..... 9  
    internal..... 45  
    Multi Interface Shoe .... 46  
Moisture condensation..... 139  
MPEG HD 422/  
MPEG HD 420..... 37, 136  
Multi/Micro USB jack ..... 12
- N**  
ND filter switch ..... 42  
Network functions..... 78  
NETWORK RESET ..... 112  
NETWORK SET menu ..... 111  
NFC..... 79  
NIGHTSHOT..... 49  
NIGHTSHOT LIGHT..... 101
- O**  
ON/STANDBY switch ..... 23  
OPERATION TIME..... 114  
OTHERS menu ..... 113  
OUTDOOR..... 43  
Output signal formats..... 72
- P**  
PEAKING ..... 118  
PICTURE PROFILE... 50, 102  
Playback..... 64  
POWER/CHG lamp..... 12  
Power cord ..... 20  
Power outlet ..... 22  
Power zoom lever ..... 33  
Pre-installed rechargeable  
battery ..... 140  
PROTECT..... 94  
Proxy recording..... 39  
    supported formats ..... 131  
PUSH button ..... 11
- R**  
REC BUTTON SET..... 32  
REC FORMAT ..... 37  
REC LAMP ..... 113  
REC/OUT SET menu ..... 102  
REC SET ..... 102  
Rechargeable battery pack ... 20  
Record button ..... 32  
Recording ..... 29  
Recording format..... 37  
Recording lamp ..... 10, 113  
Recording time ..... 126  
Relay recording ..... 31  
REMOTE CONTROL..... 113  
Remote control ..... 16  
REMOTE jack..... 15  
REPAIR IMAGE DB  
FILE ..... 97  
ROOT CERTIFICATE ..... 112  
Root certificate ..... 92
- S**  
S&Q button ..... 61  
S&Q MOTION..... 58  
SAFETY ZONE ..... 108  
SATURATION ..... 54  
SCENE SELECTION  
SET..... 48  
Screen indicators ..... 17, 68  
SDI OUT jack..... 12  
Self-diagnosis display ..... 122  
Shooting ..... 29  
SHUTTER button..... 42  
SHUTTER DISPLAY ..... 109  
Shutter speed ..... 41  
SIMUL/RELAY REC ..... 32  
Simultaneous recording..... 32  
SLOT SEL button..... 28  
Slow & Quick Motion..... 58  
    limitations ..... 130  
Smartphone..... 78

- Specifications.....142
  - START/STOP button .....30
  - STATUS button.....69
  - STATUS CHECK.....113
  - Status check .....69
  - STEADYSHOT .....100
  - STREAMING .....87, 111
  - Streaming .....87
    - supported formats .....132
  - SUMMERTIME .....113
  - Supplied accessories .....19
- T**
- TC FORMAT .....110
  - TC MAKE .....111
  - TC PRESET .....57, 118
  - TC RUN .....110
  - TC/UB DISPLAY .....110
  - TC/UB SET menu .....110
  - Telephoto .....33
  - THUMBNAIL button .....65
  - Trademarks .....148
  - Troubleshooting .....115
  - TV .....70
- U**
- UB PRESET .....57
  - UB TIME REC .....111
  - USB CONNECT .....114
  - USB LUN SET .....114
  - Using your camcorder  
abroad .....134
- V**
- VERSION DISPLAY .....114
  - VF COLOR TEMP. ....109
  - VF/LCD PANEL .....109
  - VF/LCD PANEL button .....26
  - VIDEO LIGHT .....101
  - VIDEO OUT.....103
  - VIDEO OUT jack .....12
- Viewfinder .....25
    - diopter adjustment  
dial .....25
  - VOLUME.....66, 104
- W**
- Warning indicators .....122
  - Warning messages.....123
  - WB OUTDOOR LEVEL .....99
  - WB PRESET .....99
  - WB SET .....99
  - WB SET button.....44
  - WB SHIFT .....56
  - WB TEMP SET .....99
  - White balance.....43
  - WHT BAL button .....43
  - Wi-Fi SET .....112
  - Wide angle .....33
  - Wired LAN .....86
  - WIRED LAN SET .....111
  - Wireless LAN .....82
- X**
- XAVC HD.....37, 136
  - XAVC QFHD .....37, 136
  - XLR SET.....105
- Z**
- ZEBRA.....118
  - Zoom .....33
  - ZOOM DISPLAY .....109
  - Zoom ring.....33
  - ZOOM SET.....100
- Numeric**
- 4K mode .....37
  - 60i/50i SEL .....114

## Trademarks

- “XDCAM” logo is a trademark of Sony Corporation.
- “XAVC” and  are registered trademarks of Sony Corporation.
- “AVCHD Progressive” and “AVCHD Progressive” logotype are trademarks of Panasonic Corporation and Sony Corporation.
- “Memory Stick,”  “Memory Stick Duo,” “Memory Stick PRO Duo,” “Catalyst Browse,” “Content Browser Mobile,” and “Content Browser Mobile” logo are trademarks or registered trademarks of Sony Corporation.
- “InfoLITHIUM” is a trademark of Sony Corporation.
- “BRAVIA” is a trademark of Sony Corporation.
- Dolby and the double-D symbol are trademarks of Dolby Laboratories.
- The terms HDMI and HDMI High-Definition Multimedia Interface, and the HDMI Logo are trademarks or registered trademarks of HDMI Licensing LLC in the United States and other countries.
- SDXC logo is a trademark of SD-3C, LLC.
- iPad is a trademark of Apple Inc., registered in the U.S. and other countries.
- iOS is a registered trademark or trademark of Cisco Systems, Inc. and/or its affiliates in the United States and certain other countries.
- Android, Google Play are trademarks of Google Inc.
- Wi-Fi, the Wi-Fi logo, Wi-Fi PROTECTED SET-UP are registered trademarks of the Wi-Fi Alliance.
- The N Mark is a trademark or registered trademark of NFC Forum, Inc. in the United States and in other countries.

All other product names and brand names are registered trademarks or trademarks of their respective owners. Trademarked items are not indicated by ® or ™ symbols in this manual.

## Notes on the License

ANY USE OF THIS PRODUCT OTHER THAN CONSUMER PERSONAL USE IN ANY MANNER THAT COMPLIES WITH THE MPEG-2 STANDARD FOR ENCODING VIDEO INFORMATION FOR PACKAGED MEDIA IS EXPRESSLY PROHIBITED WITHOUT A LICENSE UNDER APPLICABLE PATENTS IN THE MPEG-2 PATENT PORTFOLIO, WHICH LICENSE IS AVAILABLE FROM MPEG LA, L.L.C., 250 STEELE STREET, SUITE 300, DENVER, COLORADO 80206.

THIS PRODUCT IS LICENSED UNDER THE AVC PATENT PORTFOLIO LICENSE FOR THE PERSONAL USE OF A CONSUMER OR OTHER USES IN WHICH IT DOES NOT RECEIVE REMUNERATION TO

(i) ENCODE VIDEO IN COMPLIANCE WITH THE AVC STANDARD (“AVC VIDEO”) AND /OR

(ii) DECODE AVC VIDEO THAT WAS ENCODED BY A CONSUMER ENGAGED IN A PERSONAL ACTIVITY AND/OR WAS OBTAINED FROM A VIDEO PROVIDER LICENSED TO PROVIDE AVC VIDEO.

NO LICENSE IS GRANTED OR SHALL BE IMPLIED FOR ANY OTHER USE.

ADDITIONAL INFORMATION MAY BE OBTAINED FROM MPEG LA, L.L.C. SEE <[HTTP://WWW.MPEGLA.COM](http://www.mpegla.com)>

Software is installed in your camcorder. We provide this software based on the license agreements of the copyright owners. Based on requests by the owners of copyright of these software applications, we have an obligation to inform you of the following.

Licenses (in English) are recorded in the internal memory of your camera. Establish a Mass Storage connection between the camera and a computer to read licenses in the “PMHOME” - “LICENSE” folder.

## **On GNU GPL/LGPL applied software**

The software that is eligible for the following GNU General Public License (hereinafter referred to as “GPL”) or GNU Lesser General Public License (hereinafter referred to as “LGPL”) are included in the camcorder.

This informs you that you have a right to have access to, modify, and redistribute source code for these software programs under the conditions of the supplied GPL/LGPL.

Source code is provided on the web. Use the following URL to download it.

<http://www.sony.net/Products/Linux/>

We would prefer you do not contact us about the contents of source code.

Licenses (in English) are recorded in the internal memory of your camera. Establish a Mass Storage connection between the camera and a computer to read licenses in the “PMHOME” - “LICENSE” folder.





<http://www.sony.net/>

© 2016 Sony Corporation

Printed in China



4586803110