

NANLITE

PavoSlim 120C LED RGBWW Panel Light

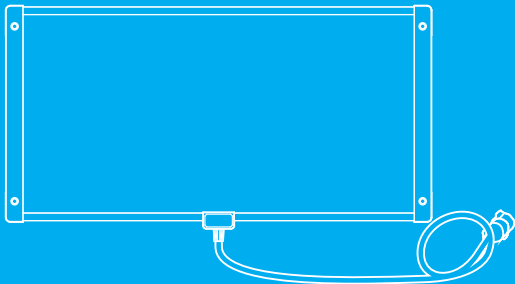

USER MANUAL

Introduction

Thank you for purchasing Nanlite product -- PavoSlim 120C!

The newly designed LED RGBWW Panel light is ready for you. It has CCT, HSI, RGBW, Gel and Effect modes built-in, with color temperature from 2700K to 7500K, ± 150 G/M adjustment, 151 gels, 15 effects and various color choices. It can be powered via the AC, DC socket and V-mount batteries including 14.4-14.8V and 26V. PavoSlim 120C also provides multiple control options of on-board, Nanlink App, DMX/RDM and LumenRadio CRMX, making it serve as a valuable tool for professional-grade production scenes. The included softbox, diffuser and eggcrate will further unleash users' creativity. With slim and lightweight fixture body of 2x1" size, PavoSlim 120C is suitable for most scenes, particularly the small space, run & gun situations, providing a great help on film and television production, photography and content creation lighting setup.

Notice

1. Please do not look directly at the emitter when the fixture is on.
2. Please do not place any object on the fixture or allow liquid to flow inside the fixture.
3. Please do not place the fixture near any flammable or volatile substances like alcohol or gasoline.
4. Please do not use strong detergent for cleaning. Please wipe off the dirt by using a cloth with neutral cleanser when cleaning the fixture.
5. Please set up the fixture in a dry and well-ventilated place. Please do not use it in any humid, dusty or overheated environment. Meanwhile, please also check whether the fan and vent are unimpeded.
6. Please do not disassemble the fixture to repair at will. Qualified professionals should conduct maintenance under the condition of strictly following the operating procedures described in this manual.
7. Please do not cover the vents when using, to avoid affecting heat dissipation, and resulting in damage. Please pay attention to anti-scald when using the fixture for a long time, since the surface temperature of fixture will be high.

PavoSlim 120C LED RGBWW Panel Light

■ Product Diagram

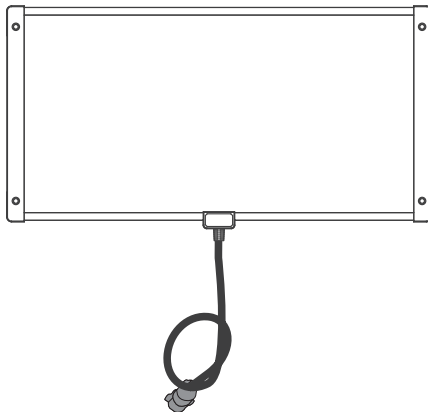

■ Technical Data

Rated Power: 150W

Input: DC 24V

DC (Battery) 14.4-26V

AC 100-240V 50/60Hz

Color Temperature: 2700K-7500K(GM±150)

CRI: Average 96

TLCI: Average 97

Product Details

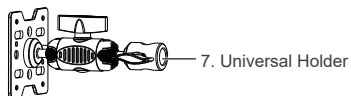
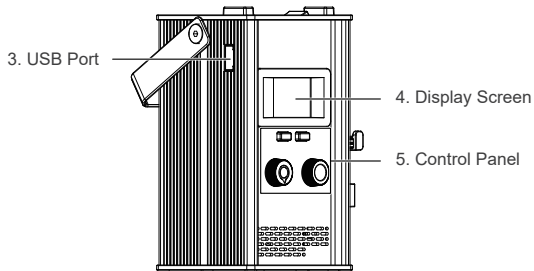
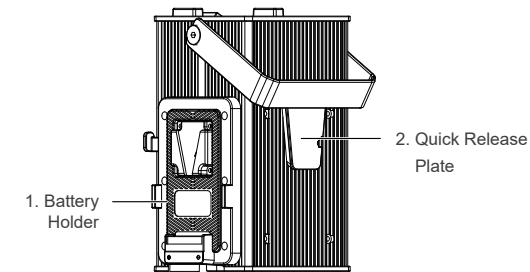



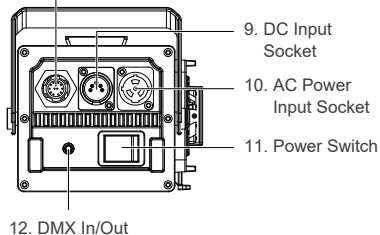





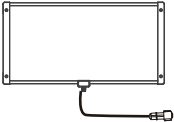
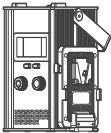

8. DC Output Socket

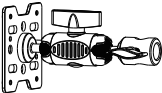

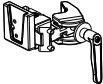
Detailed Description

1. Battery Holder: For mounting the V-mount battery.
2. Quick Release Plate: For mounting the quick release clamp.
3. USB Port: For updating firmware.
4. Display Screen: For displaying datas.
5. Control Panel: For displaying various function operations and datas.
6. Baby Pin Holder: For securing the fixture body and adjusting based on axial angles.
7. Universal Holder: For securing the fixture body and adjusting to any angle.
8. DC Output Socket: To connect the DC cable for connecting between the fixture body and control unit.
9. DC Input Socket: DC power input connector.
10. AC Power Input Socket: To connect the AC power cable to power the control unit.
11. Power Switch: To turn on/off the fixture.
12. DMX In/Out: Connect to DMX adapter cable for DMX signal input and output.
(Note: DMX adapter cable is sold separately).

Includes

PavoSlim 120C x 1	Control Unit x 1	DC Connection Cable x 1	AC Power Cable x 1
			
Universal Holder x 1	Baby Pin Holder x 1	Quick Release Clamp x 1	Diffuser x 2
			
Softbox x 1	Eggcrate x 1	Carrying Bag x 1	User Manual x 1
			

Usage

1. Connection Between Light Fixture, Control Unit and Power Supply.

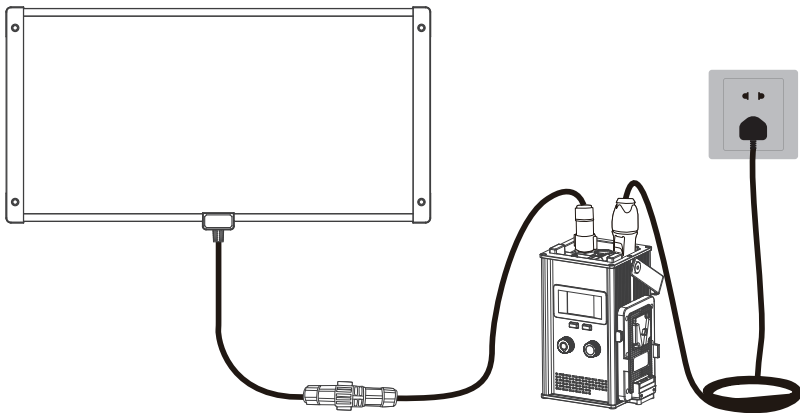

Note:

- 1.1. When connecting the power supply, please make sure the power voltage is consistent with that indicated on the control unit.
- 1.2. Make sure to use the included AC power cable and control unit. The connection between the DC output socket and the DC connection cable from the fixture body should be done as shown above.

2. Connection Between Light Fixture and Control Unit with Battery

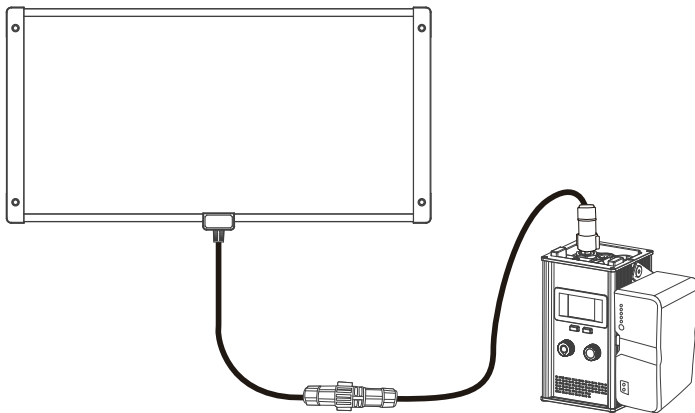

Turn off the power switch before installing the battery on the battery holder of the control unit.

▲ Note:

- 2.1 Please do not exert too much force when mounting the battery, to avoid damage and deformation of the battery holder.
- 2.2 Please press the battery lock catch when removing the battery, to avoid damage of the battery holder.
- 2.3 V-mount battery holder is for mounting 14.4-14.8V or 26V V-mount batteries.

3. Installation and Detachment of Quick Release Clamp

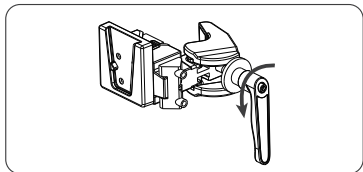

Rotate the adjustable handle to release the clamp.

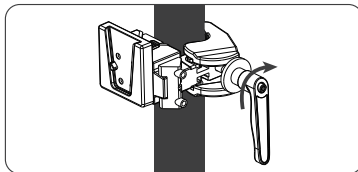

Mount the quick release clamp on the light stand, then rotate the adjustable handle to tighten the clamp.

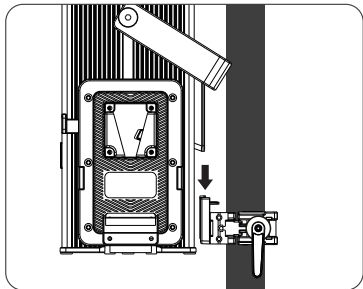

Align the quick release plate on the control unit with the quick release mount on the clamp to mount the control unit on to the clamp.

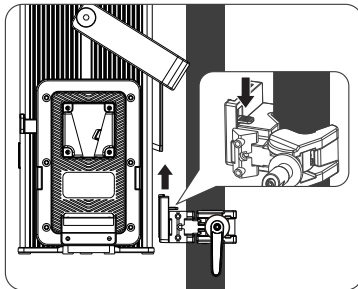

Press the lock catch on the clamp to remove the control unit from the light stand.

4. Installation of Softbox and Diffuser

4.1 Installation and Storage of Softbox

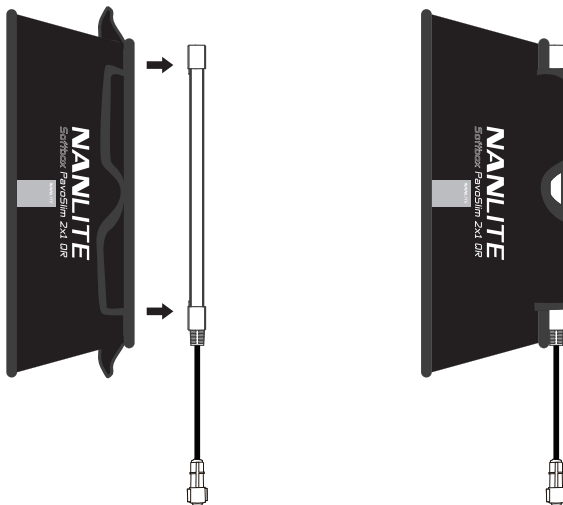

① Set the softbox upright, wrap it around the fixture and stick at the interface.

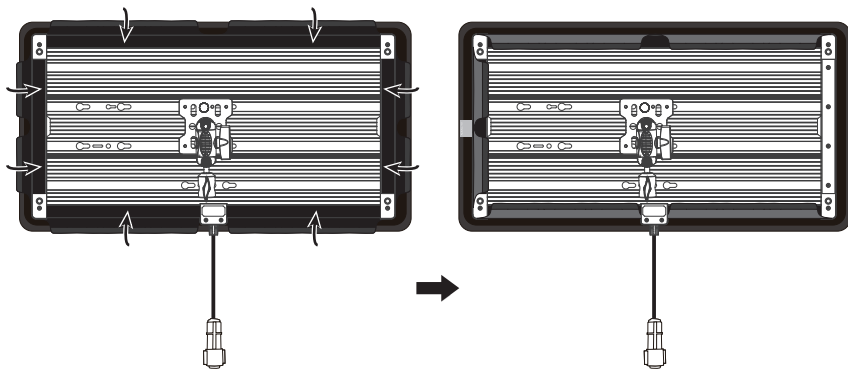

②Fasten the hook and loop fasteners to the back of fixture.

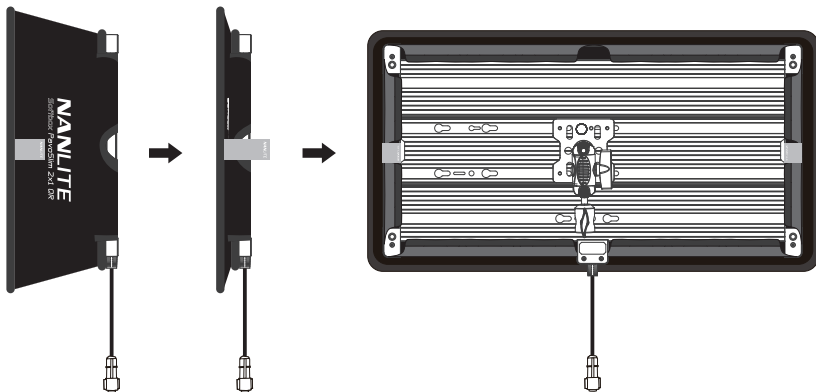

③ After use, flatten the softbox and fasten the hook and loop fasteners on both sides to the back of fixture for storage.

4.2 Installation of Diffuser and Eggcrate

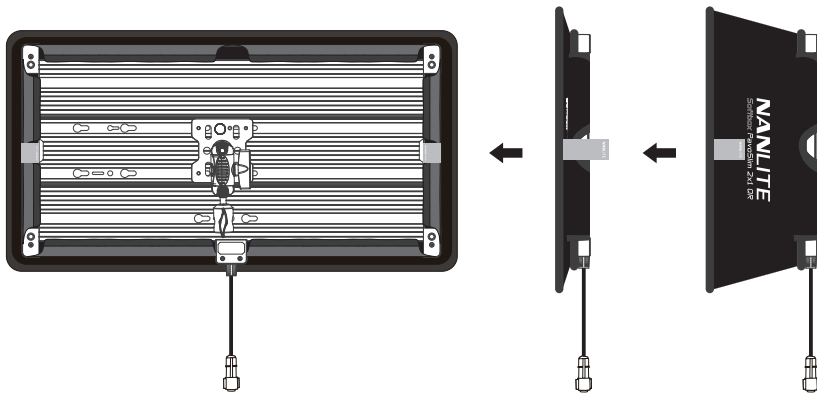

① Tear open the hook and loop fasteners on both sides, and set the softbox upright.

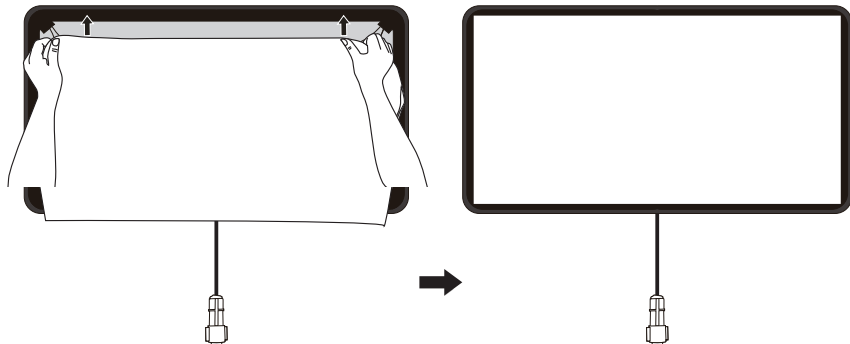

② Attach the diffuser to the hook and loop fasteners that inside the softbox.

Note: There are included two diffusers: lite diffuser and standard diffuser.

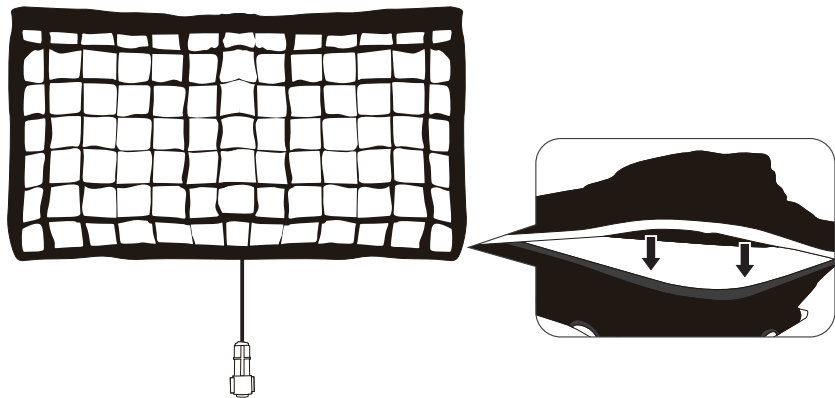

③ Wrap the eggcrate around the softbox.

5. Installation and Detachment of Universal Holder and Baby Pin Holder

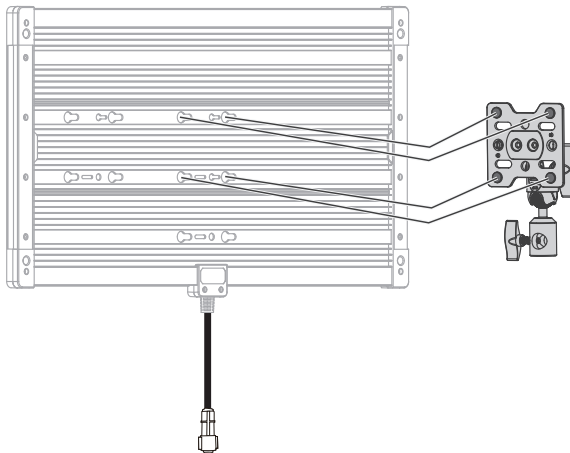

5.1 Align to the icons that on the back of fixture.

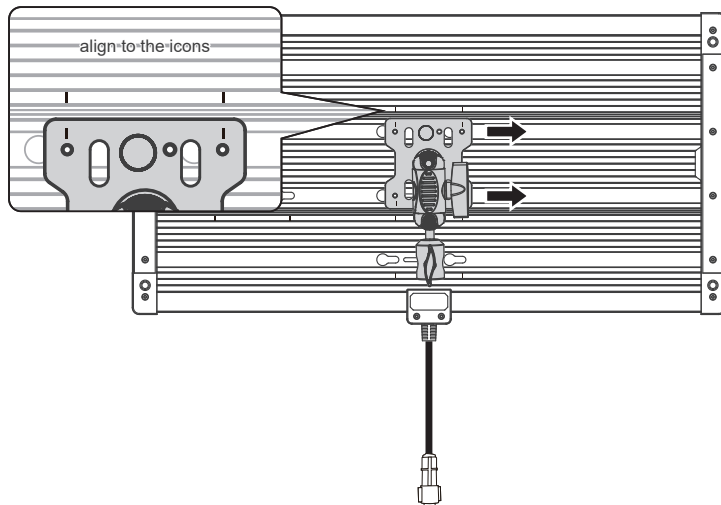

Follow the direction shown as the picture to install the universal holder.

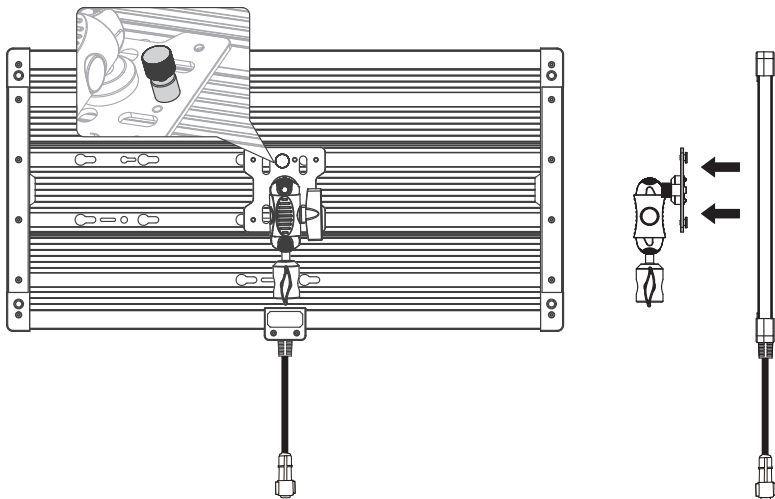

5.2 Pull up the knob of the universal holder, and slide the universal holder in the direction shown as picture above to remove it from the fixture.

· The installation and detachment method of baby pin holder is the same as that of universal holder.

Remote Control

PavoSlim 120C supports DMX/RDM, 2.4G and LumenRadio remote control, and it also has built-in Bluetooth module.

▲ The address needs to be set before operating the remote control via DMX/RDM, 2.4G and LumenRadio.

1. ADDRESS/DMX Setting, including ADDRESS, DMX MODE, DMX REDUCED CHANNELS, DMX DIMMING CURVE and DMX SMOOTHING.

1.1 ADDRESS Setting

Press the MENU button to enter the menu.

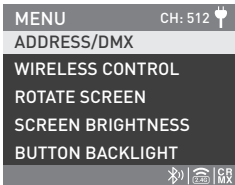

Left Knob



Right Knob



MODE



MENU

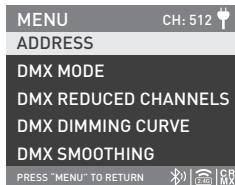
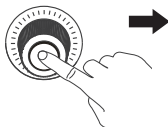
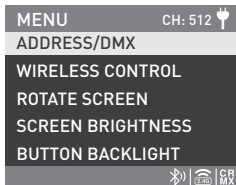

Rotate the right knob to ADDRESS/DMX, and press the right knob to enter the secondary menu.

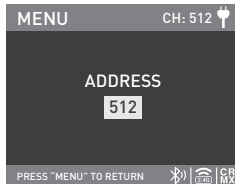
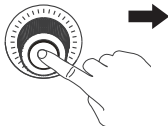
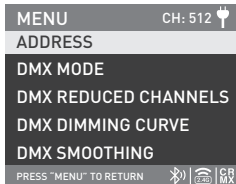

Rotate the right knob to ADDRESS, and press the right knob to enter the tertiary menu.

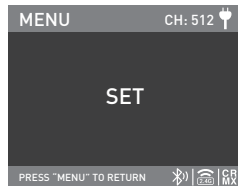
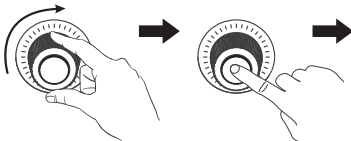
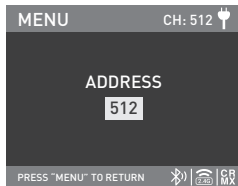

Rotate the right knob to select needed address, and press the right knob to set.

Note: PavoSlim 120C has 20 channels, for multiple lights remote control via DMX/RDM and LumenRadio, the address of the first light should be set to 001, the second one to 021, the third one to 041, and so on.

1.2 DMX MODE

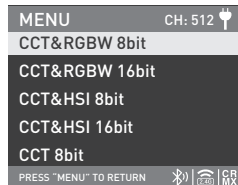
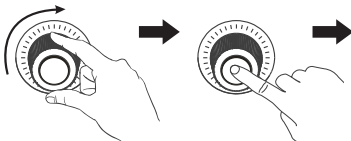
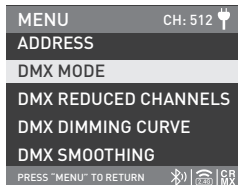

Rotate the right knob to DMX MODE, and press the right knob to enter the tertiary menu.

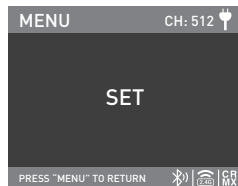
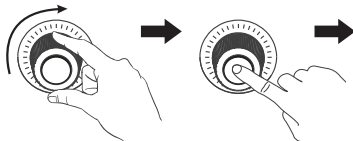
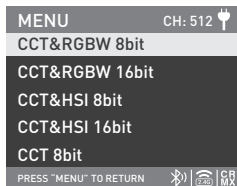

Rotate the right knob to select the needed DMX Mode, and press the right knob to set.

1.3 DMX REDUCED CHANNELS

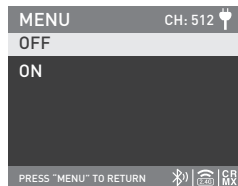
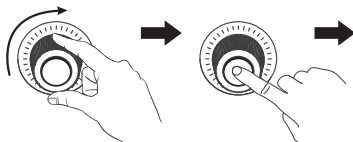
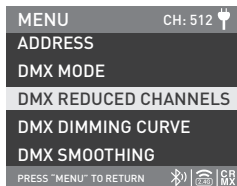

Rotate the right knob to DMX REDUCED CHANNELS, and press the right knob to enter the tertiary menu.

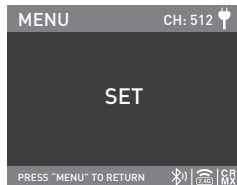
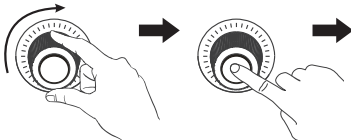

Rotate the right knob to select ON or OFF, and press the right knob to set.

1.4 DMX DIMMING CURVE

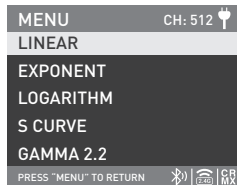
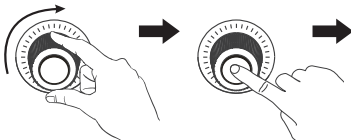
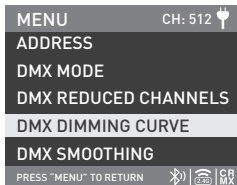

Rotate the right knob to DMX DIMMING CURVE, and press the right knob to enter the tertiary menu.

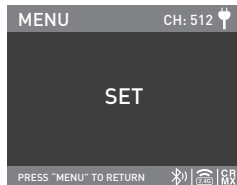
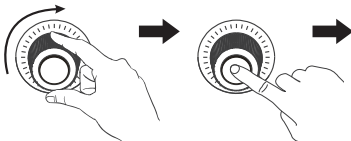
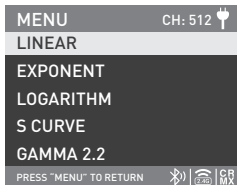

Rotate the right knob to select LINEAR, EXPONENT, LOGARITHM, S CURVE or GAMMA 2.2, and press the right knob to set.

1.5 DMX SMOOTHING

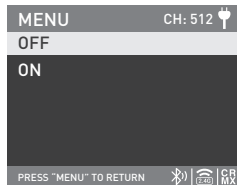
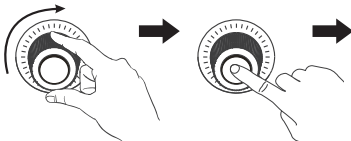
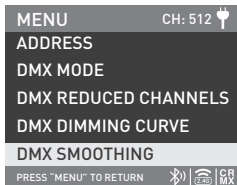

Rotate the right knob to DMX SMOOTHING, and press the right knob to enter the tertiary menu.

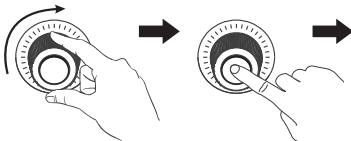
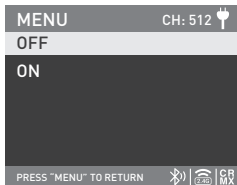

Rotate the right knob to select ON or OFF, and press the right knob to set.

2. DMX Control

2.1 Connect the fixture to the DMX/RDM consoles via DMX cable as shown below:



·5-pin shielded cable with a diameter not less than 0.3mm must be used for connection between light fixture and DMX/RDM console, or between light fixture and light fixture. XLR plug/socket and the cable should be connected as shown above.

·Pin1, Pin2, Pin3 for connecting DMX signal. Pin4, Pin5 have no connection.

▲ NOTE: When connecting DMX, make sure the internal pin is not in contact with the inner case, and pins should not be in contact with each other.

The fixture can match the DMX512 (1990) control signal.

·5-pin and 3-pin XLR plug/socket conversion

The fixture comes with 5-pin XLR plug/socket. If a 3-pin XLR plug is used, please follow the instruction below.

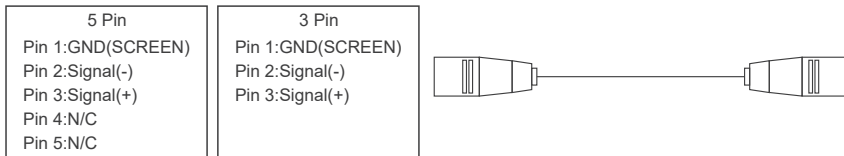

2.2 DMX Terminator

In DMX control mode, the DMX output of the last light fixture should be connected with a DMX terminator (not included).

The terminator is connected with a 120Ω(OHM) resistor across Pin 2 and Pin 3 (As shown below).

This prevents interference caused by DMX signals in the transmitting process.

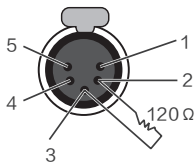

DMX Terminator Connection
 Connect a 120Ω(OHM) resistor
 across Pin 2 and Pin 3 in an XLR
 plug and insert into the DMX
 OUT socket on the last unit.

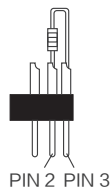

2.3 Address Setting of the Light Fixture.

2.4 Refer to the DMX reference guide and control the fixture via DMX/RDM console.

(For detailed operation please refer to the DMX/RDM console operation manual.)

2.5 The latest technical data can be download from www.nanlite.com.

3. RDM Control

3.1 Connect the light fixture to the console with RDM function by using a connection cable, the connecting method is the same as that of DMX/RDM console.

3.2 Control the fixture via a console with RDM function. (For specific operation methods, please refer to the RDM console operation manual.)

Note: The UID format of the fixture is as follow:

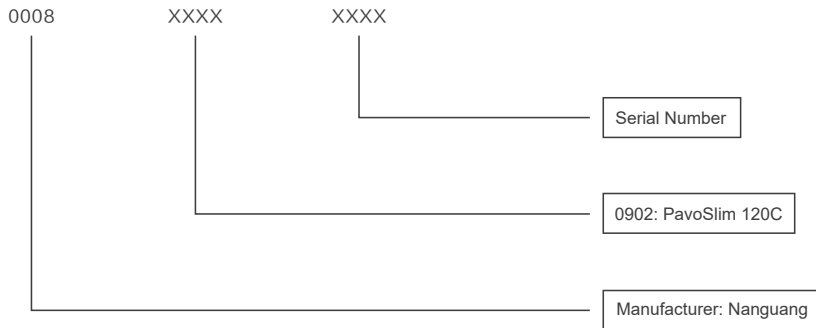

4. WIRELESS CONTROL

4.1 Bluetooth Setting

PavoSlim 120C has built-in Bluetooth function for connection via Bluetooth.

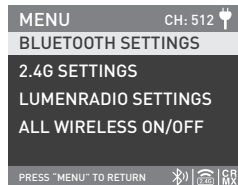
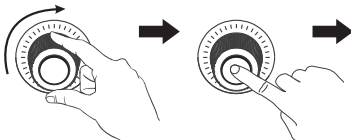
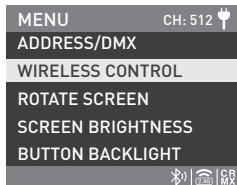

Rotate the right knob to WIRELESS CONTROL, and press the right knob to enter the secondary menu.

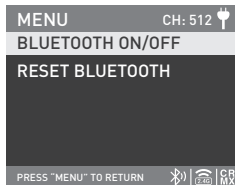
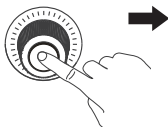
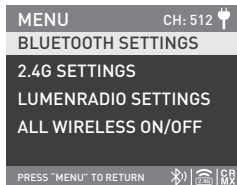

Rotate the right knob to BLUETOOTH SETTINGS, and press the right knob to enter the tertiary menu.

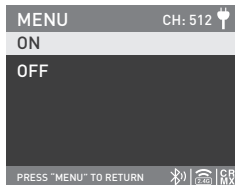
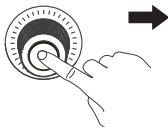
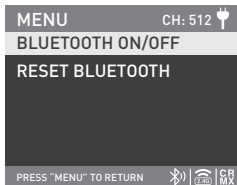

Rotate the right knob to BLUETOOTH ON/OFF, and press the right knob to enter the next menu.

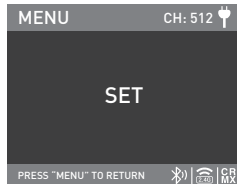
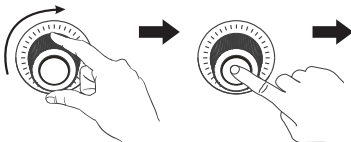
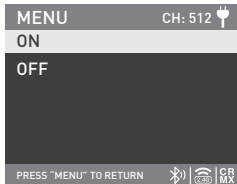

Rotate the right knob to select ON or OFF, and press the right knob to set.
The RESET BLUETOOTH is available when the Bluetooth is on.

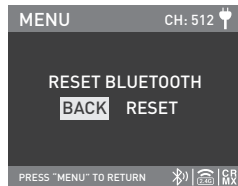
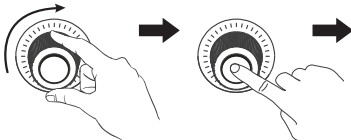
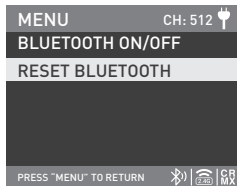

Rotate the right knob to **RESET BLUETOOTH**, and press the right knob to enter the next menu.

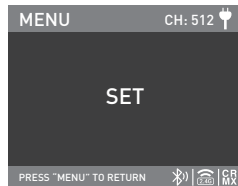
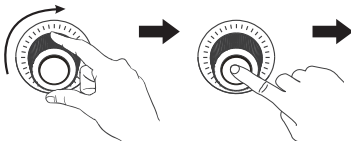
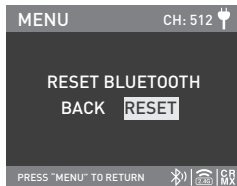

Rotate the right knob to **RESET**, and press the right knob to set.

4.2 2.4G Setting

PavoSlim 120C can be remotely controlled by 2.4G remote controller or by Nanlink App via the WS-TB-1 transmitter box.

Note: ① 2.4G remote controller and WS-TB-1 transmitter box are sold separately.

② PavoSlim 120C supports the 2.4G wireless protocol V1.0 and V2.0. The fixture should be set in V2.0 while using WS-RC-C2 remote controller, set in V1.0 while using other remote controllers.

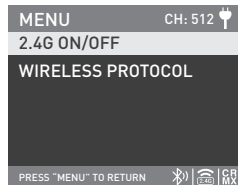
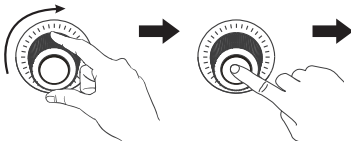
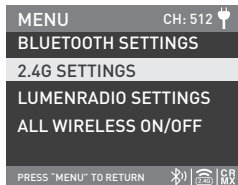

Rotate the right knob to 2.4G SETTINGS, and press the right knob to enter the tertiary menu.

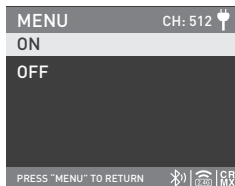
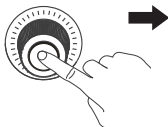
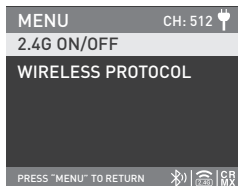

Rotate the right knob to 2.4G ON/OFF, and press the right knob to enter the next menu.

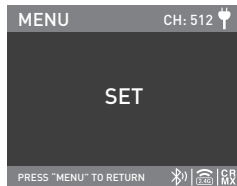
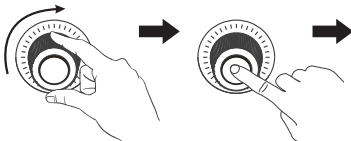
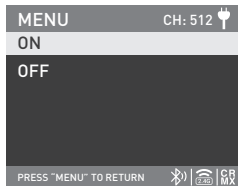

Rotate the right knob to select ON or OFF, and press the right knob to set.

The 2.4G wireless control is available when the 2.4G is set to be on.

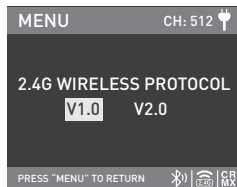
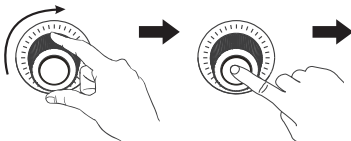
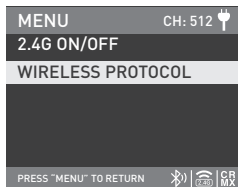

Rotate the right knob to WIRELESS PROTOCOL, and press the right knob to enter the next menu.

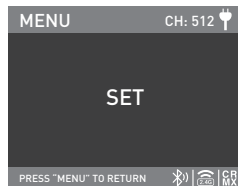
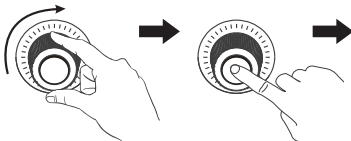
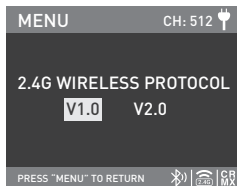

Rotate the right knob to select V1.0 or V2.0, and press the right knob to set.

4.3 LumenRadio Setting

PavoSlim 120C has built-in TIMO RX module, enabling it to receive CRMX wireless DMX signals. The specific operations are as below:

① Set the fixtures that need to receive CRMX wireless DMX signals to unlink.

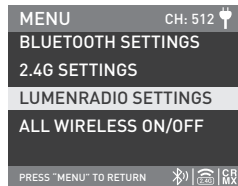
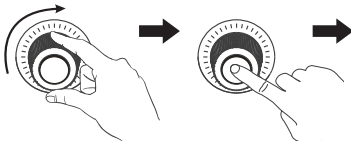
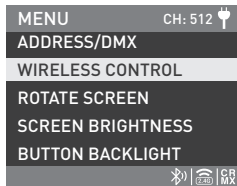

Rotate the right knob to WIRELESS CONTROL, and press the right knob to enter the secondary menu.

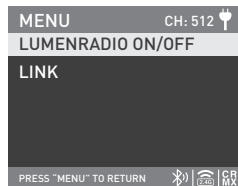
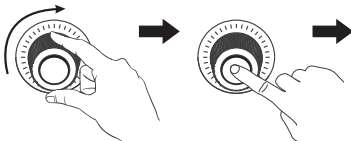
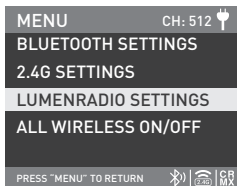

Rotate the right knob to LUMENRADIO SETTINGS, and press the right knob to enter the tertiary menu.

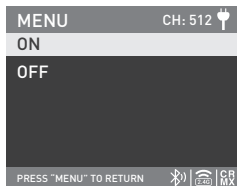
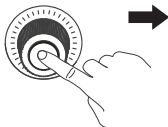
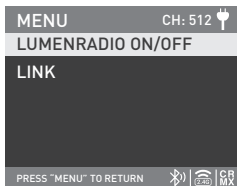

Rotate the right knob to LUMENRADIO ON/OFF, and press the right knob to enter the next menu.

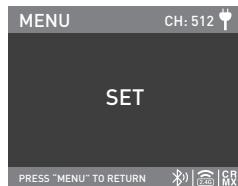
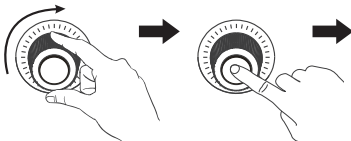
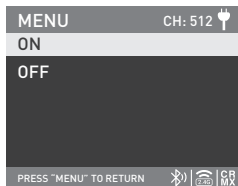

Rotate the right knob to select ON or OFF, and press the right knob to set.

The PavoSlim 120C can receive CRMX wireless DMX signals when the LumenRadio is set to be on.

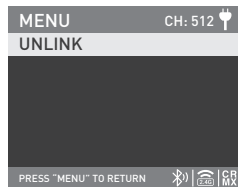
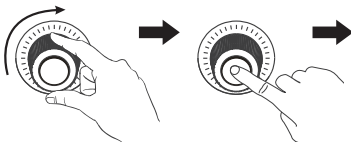
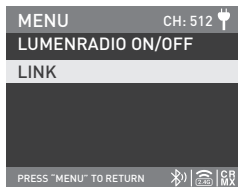

Rotate the right knob to LINK, and press the right knob to enter the tertiary menu.

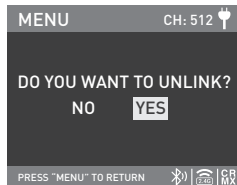
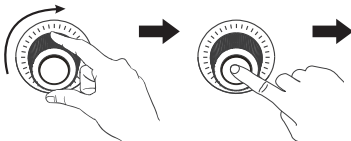
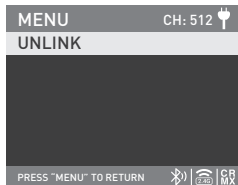

Rotate the right knob to UNLINK, and press the right knob to enter the next menu.

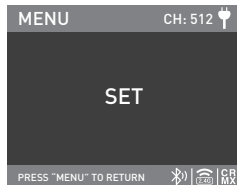
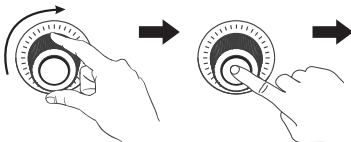
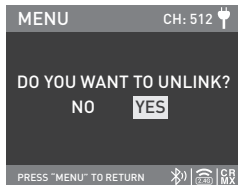

Rotate the right knob to select YES, and press the right knob to set.

② Connect and control the light fixture that set to transmitter mode or CRMX wireless DMX transmitter with the light fixture that needs to receive the CRMX wireless DMX signal.

Note: The light fixture can only be reconnected to the new fixtures or transmitters after set to unlink.

4.4 All Wireless On/Off

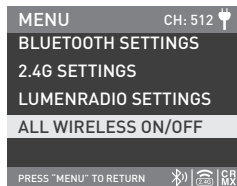
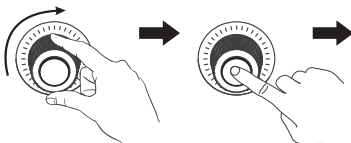
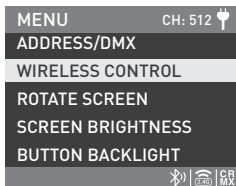

Rotate the right knob to WIRELESS CONTROL, and press the right knob to enter the secondary menu.

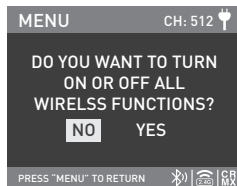
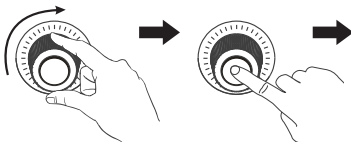
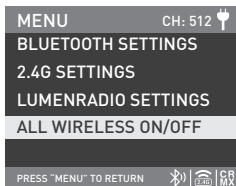

Rotate the right knob to ALL WIRELESS ON/OFF, and press the right knob to enter the tertiary menu.

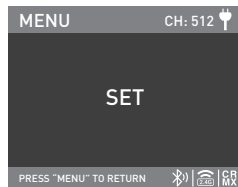
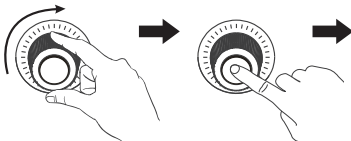
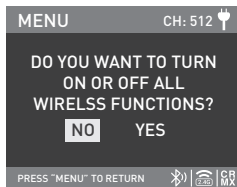

Rotate the right knob to select ON or OFF, and press the right knob to set.

When all wireless functions are set to be on, the Bluetooth, 2.4G and LumenRadio settings will be in the ON state.

When all wireless functions are set to be off, the Bluetooth, 2.4G and LumenRadio settings will be in the OFF state.

Operating Instructions

1. Make sure the control unit is off, connect with the fixture, and connect to mains electricity via the power cable or mount the battery, and turn on the power switch, the screen will display "NANLITE".
2. MODE button: Press the MODE button to enter the lighting mode interface.
(The lighting modes include CCT, HSI, RGBW, GEL and Effect modes.)

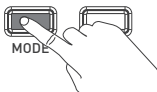
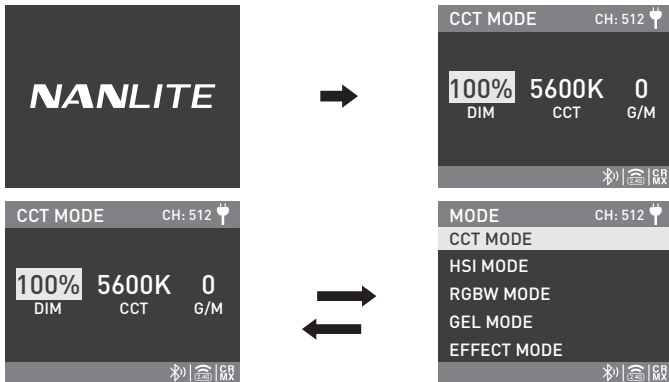

Press the MODE button to enter one lighting mode.
Press the MODE button again to return to the lighting mode list interface.

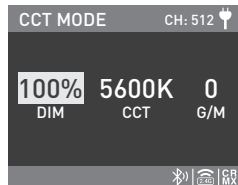
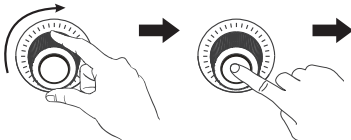
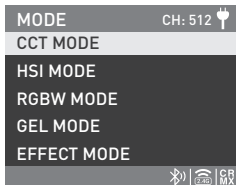

Rotate the right knob to select the needed lighting mode, and press the right knob to enter the corresponding lighting mode.

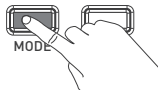
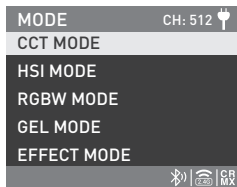
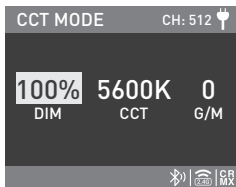

Press the MODE button again to return to the lighting mode list interface.

2.1 CCT Mode

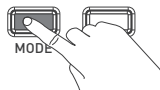
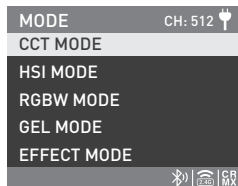

Left Knob



Right Knob

Press the MODE button to enter the lighting mode list interface.

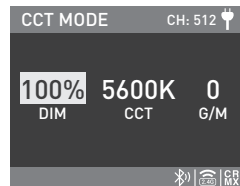
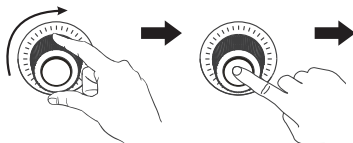
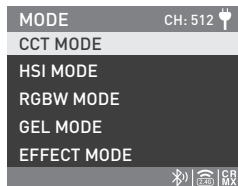

Rotate the right knob to CCT MODE, and press the right knob to enter the interface.

CCT MODE Setting: Rotate the right knob to select DIM, CCT (range: 2700K-7500K) or G/M (range: -150 to 150), then rotate the left knob and set the corresponding parameters.

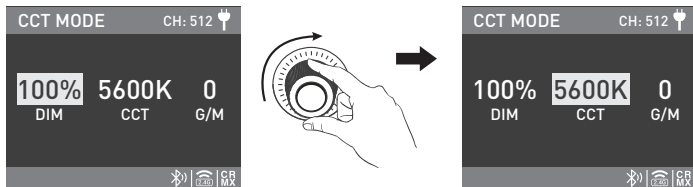

Rotate the right knob to select DIM, CCT or G/M.

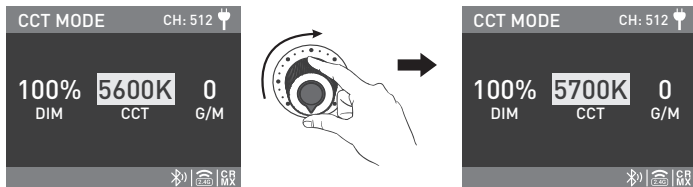

Rotate the left knob to set the corresponding parameters.

2.2 HSI MODE

HSI MODE Setting: Rotate the right knob to select DIM, HUE (range: 0-360) or SAT (range: 0-100), and rotate the left knob to set the corresponding parameters.

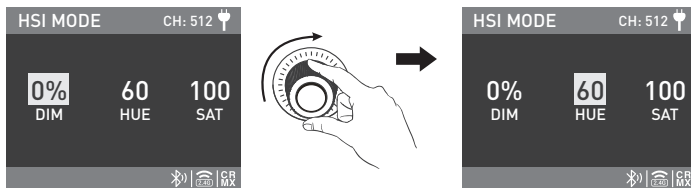

Rotate the right knob to select DIM, HUE or SAT.

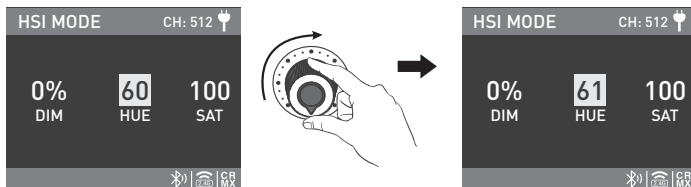

Rotate the left knob to set the corresponding parameters.

Note: In other modes, the adjustment range of HUE and SAT is the same as that in HSI Mode.

2.3 RGBW MODE

RGBW MODE Setting: Rotate the right knob to select red, green, blue or white, and rotate the left knob to adjust the DIM and the corresponding red, green, blue and white values (adjustment range: 0-255).

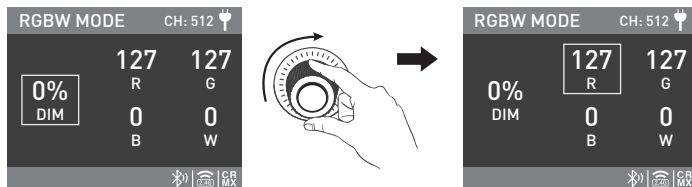

Rotate the right knob to select DIM, red, green, blue or white.

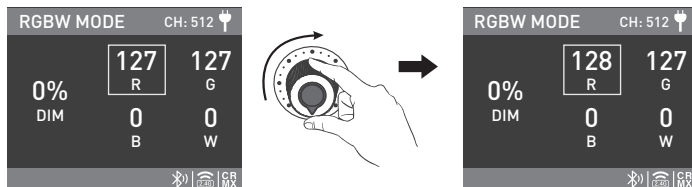

Rotate the left knob to adjust DIM and the corresponding red, green, blue and white values.

2.4 GEL MODE

GEL MODE Setting: Rotate the right knob to adjust the DIM, CCT (3200K or 5600K) and GEL, and rotate the left knob to set the corresponding parameters.

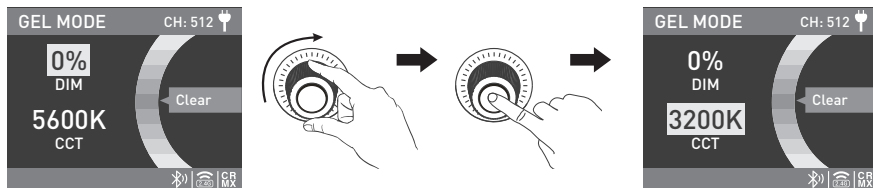

Rotate the right knob to adjust the DIM, CCT and GEL.

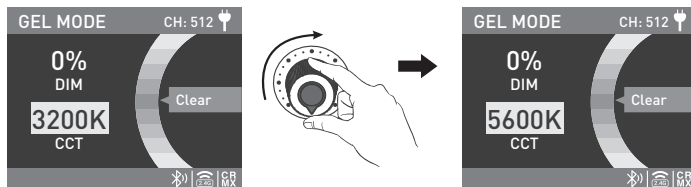

Rotate the left knob to set the corresponding parameters.

2.5 EFFECT MODE

PavoSlim 120C has built-in effects including: HUE Loop, CCT Loop, INT Loop, Flash, Pulse, Storm Auto, Storm Manual, Police Car, TV, Paparazzi, Candle/Fire, Disco, Bad Bulb, Firework, Explosion Auto, Explosion Manual and Welding.

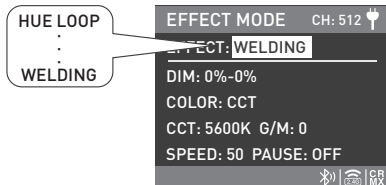
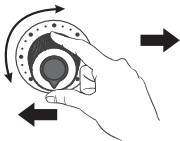
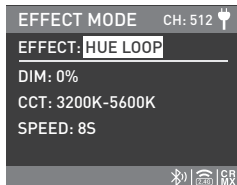

Rotate the left knob to select the needed effect, which can be selected in a loop.

① HUE LOOP

HUE LOOP setting, rotate the right knob to select DIM, HUE, SAT or SPEED (range: 2s-30s), and rotate the left knob to set the corresponding parameters.

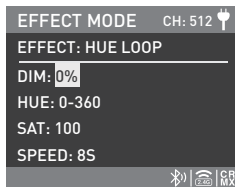
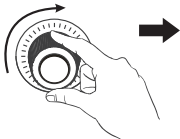
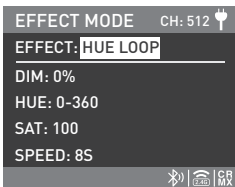

Rotate the right knob to select DIM, HUE, SAT or SPEED.

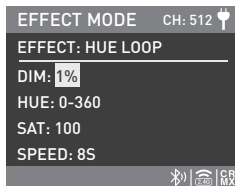
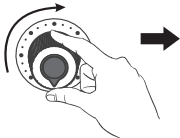
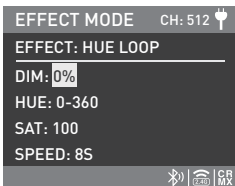

Rotate the left knob to set the corresponding parameters.

② CCT LOOP

CCT LOOP setting, rotate the right knob to select DIM, CCT, G/M or SPEED (2s-30s), and rotate the left knob to set the corresponding parameters.

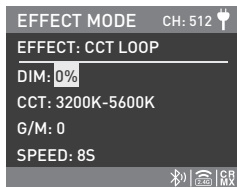
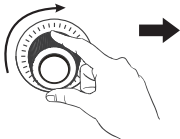
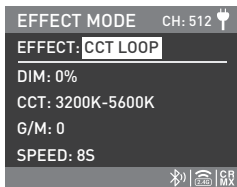

Rotate the right knob to select DIM, CCT, G/M or SPEED.

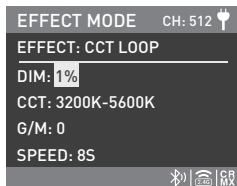
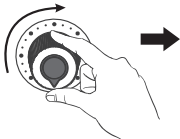
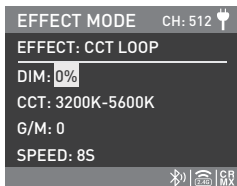

Rotate the left knob to set the corresponding parameters.

③INT LOOP

INT LOOP setting, rotate the right knob to select DIM and COLOR (including CCT and HSI).

When the color is CCT, rotate the right knob to select CCT, G/M or SPEED (range: 2s-30s), and rotate the left knob to set the corresponding parameters.

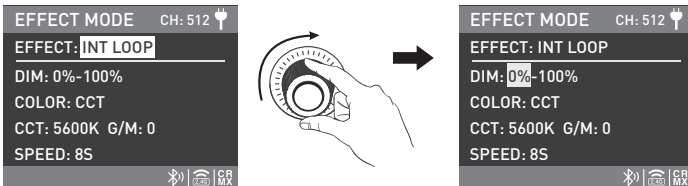

Rotate the right knob to select CCT, G/M or SPEED.

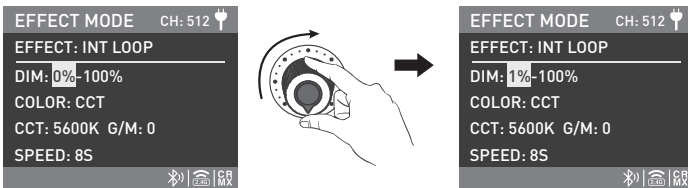

Rotate the left knob to set the corresponding parameters.

When the color is HSI, rotate the right knob to select HUE, SAT or SPEED (range: 2s -30s), and rotate the left knob to set the corresponding parameters (same operation method as in CCT).

④FLASH

FLASH setting, rotate the right knob to select DIM and COLOR (including CCT and HSI).

When the color is CCT, rotate the right knob to select CCT, G/M or INTERVALS (range: 0.1s-10.0s), and rotate the left knob to set the corresponding parameters.

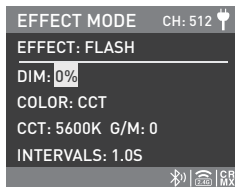
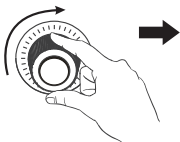
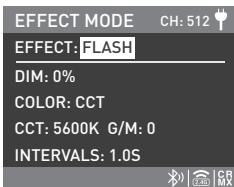

Rotate the right knob to select CCT, G/M or INTERVALS.

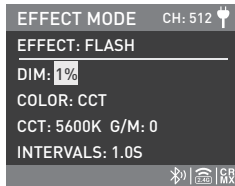
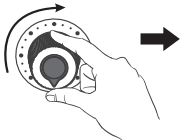
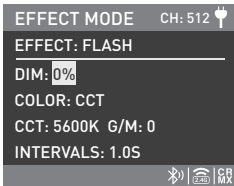

Rotate the left knob to set the corresponding parameters.

When the color is HSI, rotate the right knob to select HUE, SAT or INTERVALS, and rotate the left knob to set the corresponding parameters (same operation method as in CCT).

⑤ PULSE

PULSE setting, rotate the right knob to select DIM and COLOR (including CCT and HSI).

When the color is CCT, rotate the right knob to select CCT, G/M or PULSES/MIN (range: 1-240), and rotate the left knob to set the corresponding parameters.

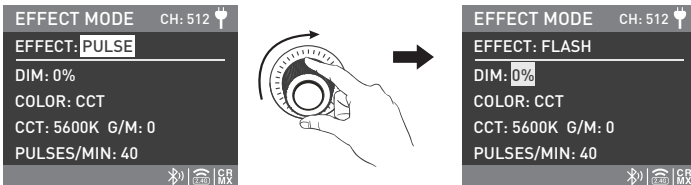

Rotate the right knob to select CCT, G/M or PULSES/MIN.

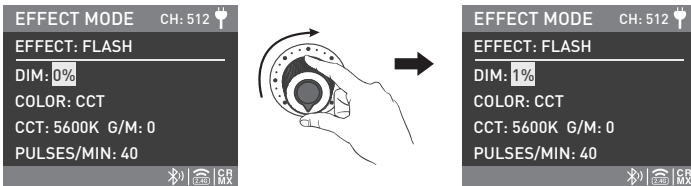

Rotate the left knob to set the corresponding parameters.

When the color is HSI, rotate the right knob to select HUE, SAT or PULSES/MIN (range: 1-240), and rotate the left knob to set the corresponding parameters (same operation method as in CCT).

ⓐ STORM AUTO

STORM AUTO setting, rotate the right knob to select DIM, CCT or INTERVAL RANGE (range: 1S-60S) , and rotate the left knob to set the corresponding parameters.

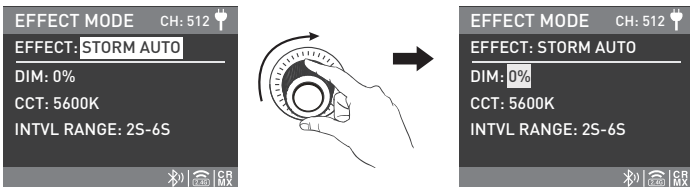

Rotate the right knob to select DIM, CCT or INTERVAL RANGE.

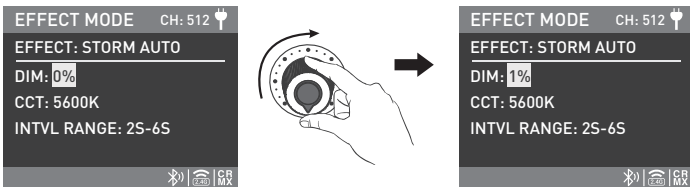

Rotate the left knob to set the corresponding parameters.

⑦ STORM MANUAL

STORM MANUAL setting, rotate the right knob to select DIM or CCT, and rotate the left knob to set the corresponding parameters, press the right knob to trigger the storm effect.

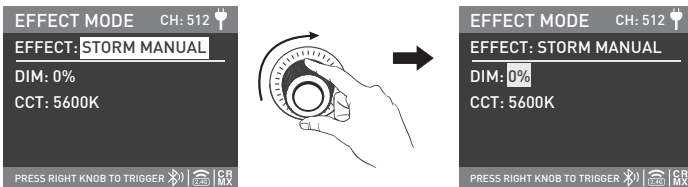

Rotate the right knob to select DIM or CCT.

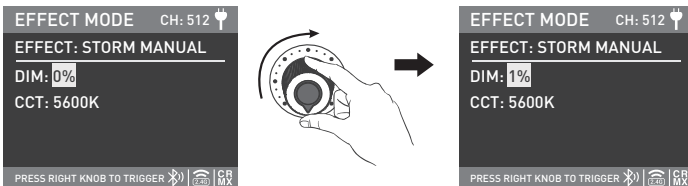

Rotate the left knob to set the corresponding parameters.

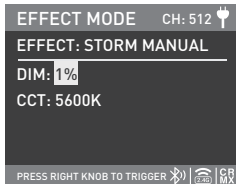

Press the right knob to trigger the storm effect.

ⓈPOLICE CAR

POLICE CAR setting, rotate the right knob to select DIM, COLOR, MODE or SPEED (range: 1-100), the COLOR includes BLUE, RED & BLUE, BLUE & WHITE and RED & BLUE & WHITE, the MODE Includes SINGLE, DOUBLE, TRIPLE and QUAD.

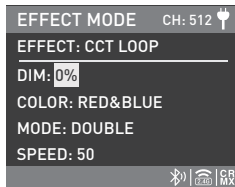
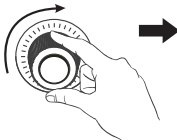
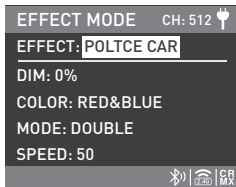

Rotate the right knob to select DIM, COLOR, MODE or SPEED.

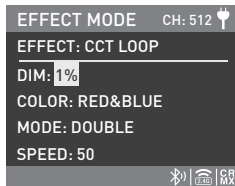
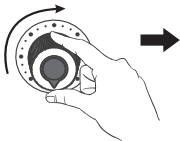
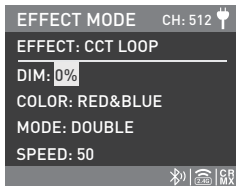

Rotate the left knob to set the corresponding parameters.

Ⓒ TV

TV setting, rotate the right knob to select DIM and COLOR (including CCT and HSI).

When the color is CCT, rotate the right knob to select CCT, G/M or SPEED (range: 1-100), and rotate the left knob to set the corresponding parameters.

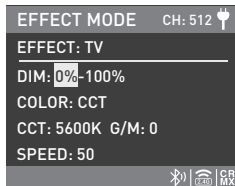
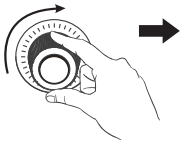
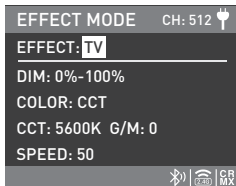

Rotate the right knob to select CCT, G/M or SPEED.

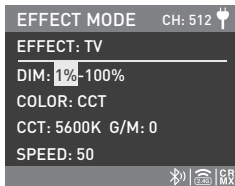
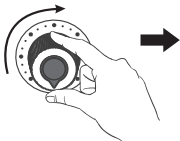
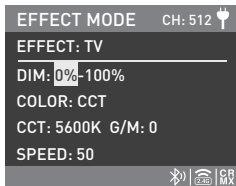

Rotate the left knob to set the corresponding parameters.

When the color is HSI, rotate the right knob to select HUE, SAT or SPEED (range: 1-100), and rotate the left knob to set the corresponding parameters (same operation method as in CCT).

⑩ PAPARAZZI

PAPARAZZI setting, rotate the right knob to select DIM, CCT, G/M or SPEED (range: 1-100), and rotate the left knob to set the corresponding parameters.

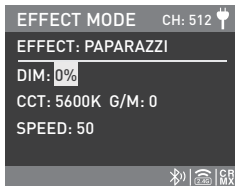
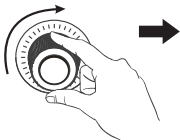
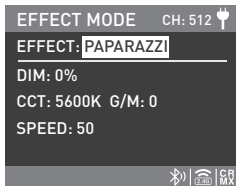

Rotate the right knob to select DIM, CCT, G/M or SPEED.

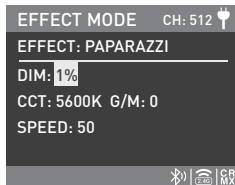
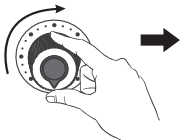
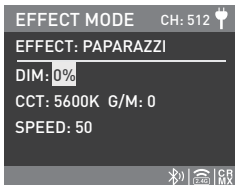

Rotate the left knob to set the corresponding parameters.

⑩ CANDLE/FIRE

CANDLE/FIRE setting, rotate the right knob to select DIM and COLOR (including CCT and HSI).

·When the color is CCT, rotate the right knob to select CCT, G/M or SPEED (range: 1-100), and rotate the left knob to set the corresponding parameters.

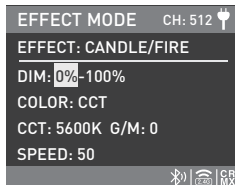
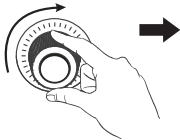
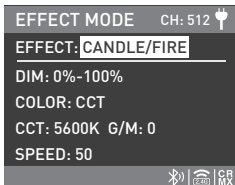

Rotate the right knob to select CCT, G/M or SPEED.

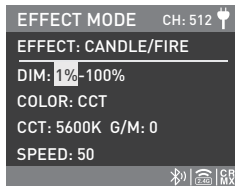
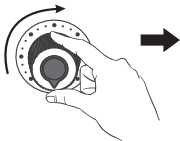
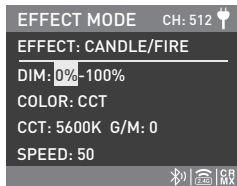

Rotate the left knob to set the corresponding parameters.

When the color is HSI, rotate the right knob to select HUE, SAT or SPEED (range: 1-100), and rotate the left knob to set the corresponding parameters (same operation method as in CCT).

DISCO

DISCO setting, rotate the right knob to select DIM, AMOUNT (range: 3, 6, 9, 12, 15, 18, 21, 24), SPEED (range: 1-100) or SAT, and rotate the left knob to set the corresponding parameters.

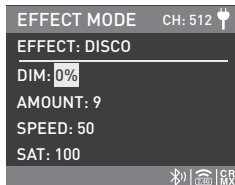
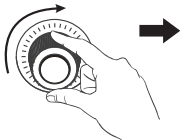
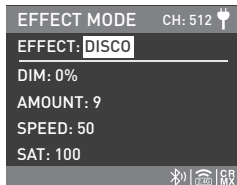

Rotate the right knob to select DIM, AMOUNT, SPEED or SAT.

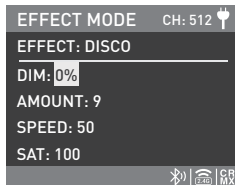
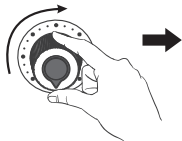
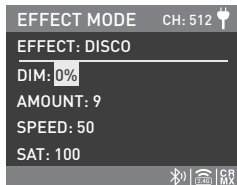

Rotate the left knob to set the corresponding parameters.

⑬BAD BULB

BAD BULB setting, rotate the right knob to select DIM and COLOR (including CCT and HSI).

When the color is CCT, rotate the right knob to select CCT, G/M or SPEED (range: 1-100), and rotate the left knob to set the corresponding parameters.

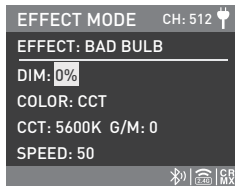
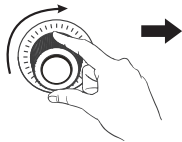
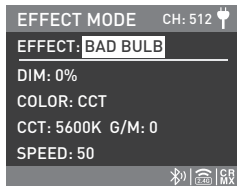

Rotate the right knob to select CCT, G/M or SPEED.

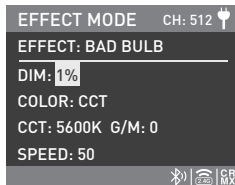
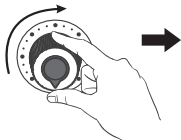
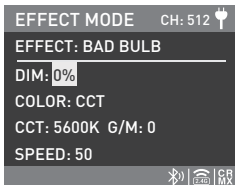

Rotate the left knob to set the corresponding parameters.

When the color is HSI, rotate the right knob to select HUE, SAT or SPEED (range: 1-100), and rotate the left knob to set the corresponding parameters (same operation method as in CCT).

⑭ FIREWORK

FIREWORK setting, rotate the right knob to select DIM, AMOUNT (range: 3, 6, 9, 12, 15, 18, 21, 24), SPEED (range: 1-100), DECAY (range: 1-100) or SAT, and rotate the left knob to set the corresponding parameters.

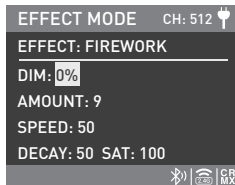
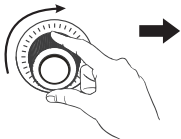
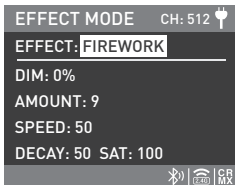

Rotate the right knob to select DIM, AMOUNT, SPEED, DECAY or SAT.

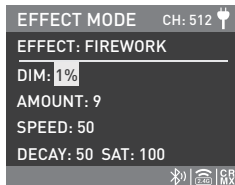
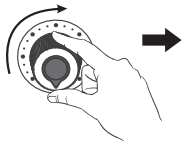
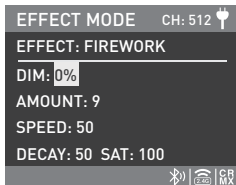

Rotate the left knob to set the corresponding parameters.

ⓈEXPLOSION AUTO

EXPLOSION AUTO setting, rotate the right knob to select DIM and COLOR (including CCT and HSI).

When the color is CCT, rotate the right knob to select CCT, G/M or SPEED (range: 1-100), and rotate the left knob to set the corresponding parameters.

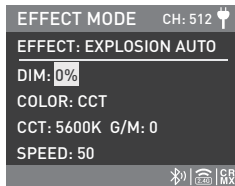
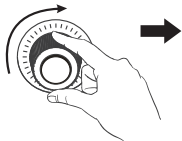
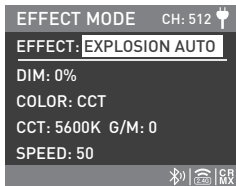

Rotate the right knob to select CCT, G/M or SPEED.

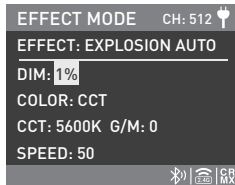
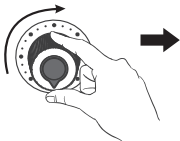
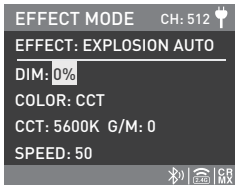

Rotate the left knob to set the corresponding parameters.

When the color is HSI, rotate the right knob to select HUE, SAT or SPEED (range: 1-100), and rotate the left knob to set the corresponding parameters (same operation method as in CCT).

⑩ EXPLOSION MANUAL

EXPLOSION MANUAL setting, rotate the right knob to select DIM and COLOR (including CCT and HSI).

When the color is CCT, rotate the right knob to select CCT or G/M, and rotate the left knob to set the corresponding parameters. Press the right knob to trigger the explosion effect.

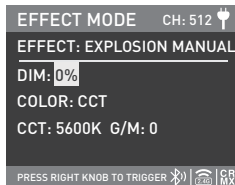
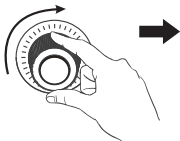
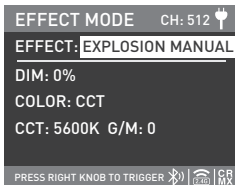

Rotate the right knob to select CCT or G/M.

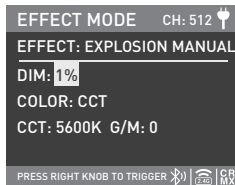
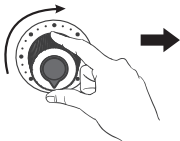
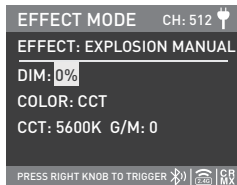

Rotate the left knob to set the corresponding parameters.

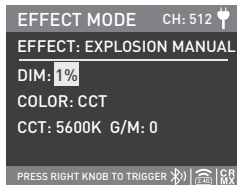

Press the right knob to trigger the storm effect.

When the color is HSI, rotate the right knob to select HUE or SAT, and rotate the left knob to set the corresponding parameters (same operation method as in CCT).

⑰ WELDING

WELDING setting, rotate the right knob to select DIM and COLOR (including CCT and HSI).

When the color is CCT, rotate the right knob to select CCT, G/M, SPEED (range: 1-100) or PAUSE, and rotate the left knob to set the corresponding parameters.

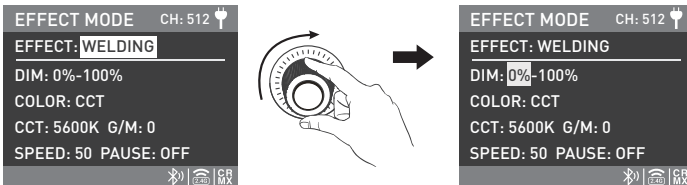

Rotate the right knob to select CCT, G/M, SPEED or PAUSE.

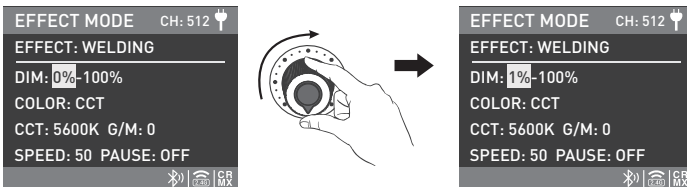

Rotate the left knob to set the corresponding parameters.

When the color is HSI, rotate the right knob to select HUE, SAT, SPEED or PAUSE, and rotate the left knob to set the corresponding parameters (same operation method as in CCT).

3. MENU Button: Press the MENU button to enter the interface of menu.

Rotate the right knob to select the options, press the right knob to enter the secondary menu, and rotate the right knob to select the corresponding parameters, then press the right knob to set. Press the MENU button to return to the previous menu.

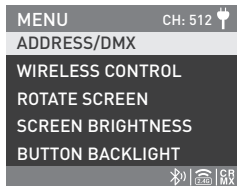

Left knob



Right Knob

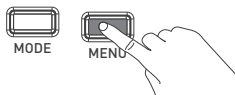

3.1 ADDRESS/DMX

For detailed operations please refer to P18.

3.2 WIRELESS CONTROL

For detailed operations please refer to P27.

3.3 ROTATE SCREEN

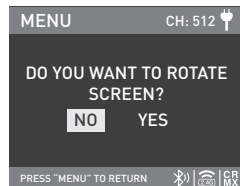
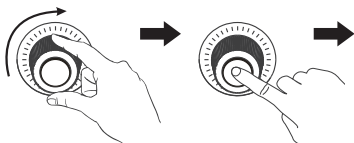
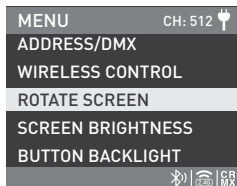

Rotate the right knob to ROTATE SCREEN, and press the right knob to enter the secondary menu.

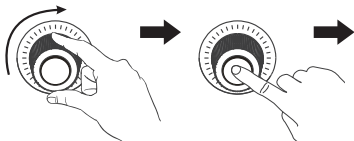
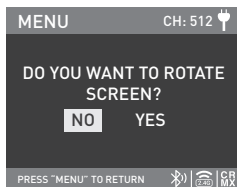

Rotate the right knob to select YES or NO, and press the right knob to set.

3.4 SCREEN BRIGHTNESS

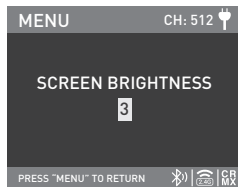
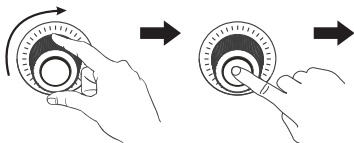
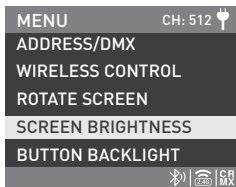

Rotate the right knob to SCREEN BRIGHTNESS, and press the right knob to enter the secondary menu.

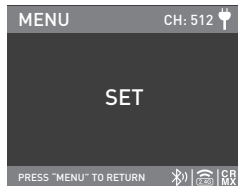
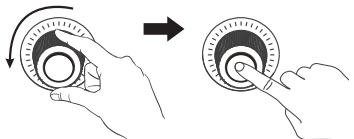
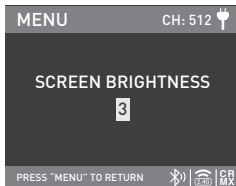

Rotate the right knob to select the screen brightness, and press the right knob to set.

3.5 BUTTON BACKLIGHT

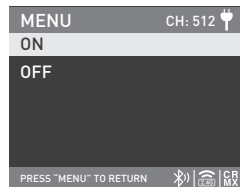
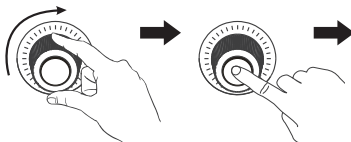
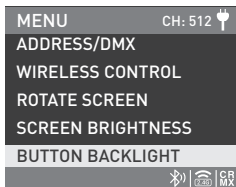

Rotate the right knob to **BUTTON BACKLIGHT**, and press the right knob to enter the secondary menu.

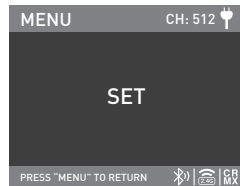
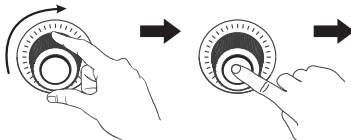
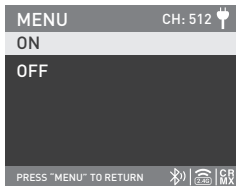

Rotate the right knob to select **ON** or **OFF**, and press the right knob to set.

3.6 LANGUAGE

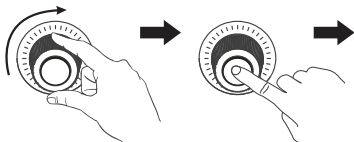
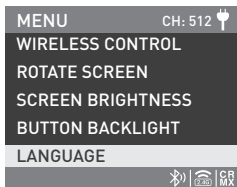

Rotate the right knob to the LANGUAGE, and press the right knob to enter the secondary menu.

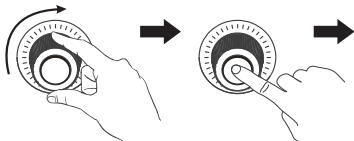

Rotate the right knob to ENGLISH or 简体中文, and press the right knob to set.

3.7 FIRMWARE UPDATE

Put the two firmware files into the root directory of the USB drive (ensure the firmware versions match), and insert the USB drive to the USB port.

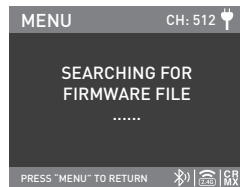
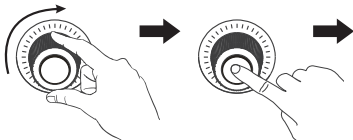
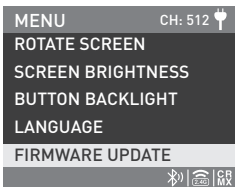

Rotate the right knob to FIRMWARE UPDATE, press the right knob to enter the interface to search for the firmware files.

Note:

- ① Please do not rename the firmware files.
- ② Ensure the USB drive is formatted to FAT, FAT32 or exFAT.
- ③ If prompted that "NO FIRMWARE FOUND", please check whether the firmware files are correct, whether the firmware files are put in the root directory of the USB drive, or whether the USB drive format is FAT, FAT32 or exFAT.
- ④ If all the above steps are done and the firmware files still cannot be found, please format the USB drive again.
- ⑤ If the fixture still cannot identify the USB drive, please replace the USB drive.

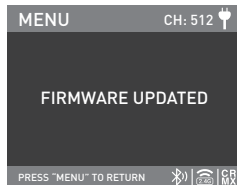
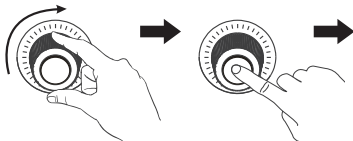
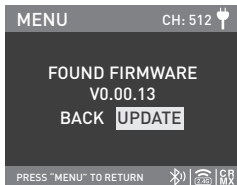

After firmware file is found, enter the firmware update interface, rotate the right knob to select UPDATE, and press the right knob to make update. After update, the light fixture will automatically restart.

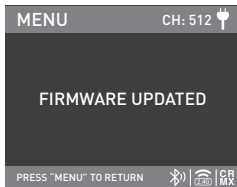

3.8 RESET ALL SETTING

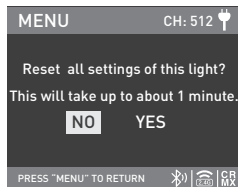
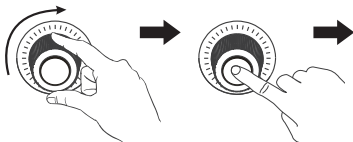
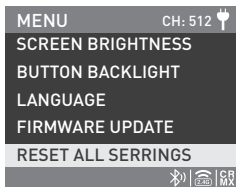

Rotate the right knob to **RESET ALL SETTINGS**, and press the right knob to enter the secondary menu.

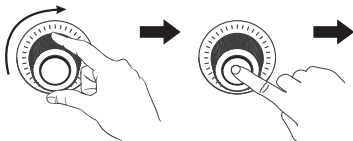
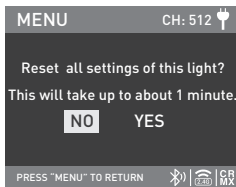

Rotate the right knob to select **YES** or **NO**, and press the right knob to set.

3.9 VERSION

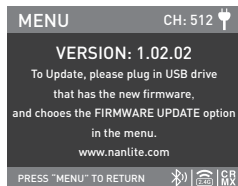
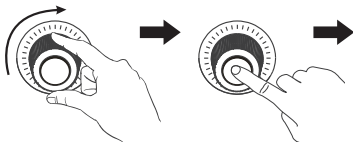
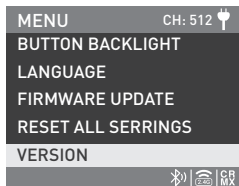

Rotate the right knob to VERSION, and press the right knob to check the current version.

4. When the fixture is not in use, please turn off the power switch.

General Fault Detection and Diagnosis

Fault Detection	Diagnosis
The light won't boot up properly.	<ol style="list-style-type: none"><li data-bbox="621 225 1222 282">1. Please check whether the connection between the control unit and power cable or the fixture are loose.<li data-bbox="621 293 1205 353">2. Please check whether the voltage value of control unit is within the specified range.
The fixture can be operated manually, but DMX control is not working.	<ol style="list-style-type: none"><li data-bbox="621 410 1222 433">1. Please check whether the DMX address setting is correct.<li data-bbox="621 443 1245 503">2. Please check whether the DMX cable is connected correctly and without damage.

Certification



Made in China

Please scan the QR code for more details.



DMX Reference Guide



Detailed User Manual



Nanlite Website



Nanlink App

This manual has been compiled according to the rigorous testing for Nanlite products. Product designs are subject to change without prior notice. The latest version of the manual for this product is downloadable at www.nanlite.com.

WWW.NANLITE.COM

NANLITE

 0754-85751187

 info@nanlite.com

 0754-85300887

 Dongli Section, Highway 324, Chenghai, Shantou City, Guangdong Province, China